



# PRODUCT CATALOG

Vol. **14.0**

*Experience the Clover difference.*



**CLOVER MFG. CO.,LTD.**

Clover manufactures products that are safe and reliable from the customers' perspective, and which are also environmentally friendly.



### Clover's Quality Policy

- We maximize our corporate value by manufacturing products that satisfy and resonate with customers.
- We reflect customers' demands and expectations into product manufacturing.
- We actively respond to environmental issues under our motto of being a company that is friendly to people and the environment.



#### Our Symbol of Commitment to Quality

- Origin of our Clover Mark -

When Toshio Okada, the founder of Clover MFG. Co., Ltd., started to work for a needle wholesaler in Osaka at the age of 14, his mentor gave him a textbook on moral philosophy. As a bookmark for this book, Toshio used a clover leaf grown in his hometown. In 1925, he opened his own shop, and soon after World War II, began manufacturing products on a full scale to provide consumers with needles and sewing tools. That was when he decided to use the design of the clover leaf—sandwiched between the pages of a book he had when he left home—as a mark to assure product quality. Although needles are small items, they are essential to people's daily life, just like water and salt. The Clover Mark continues to represent the founder's philosophy of assuring quality and taking responsibility for even the smallest products the company offers.

#### Clover's environmental initiatives Obtained ISO 14001 certification



ISO 14001 certified  
Clover Mfg. Co., Ltd.  
Higashiosaka Office

Clover's Higashiosaka Office (including Osaka Factory and Central Distribution Center) acquired the international ISO 14001 environmental standard in 2000. The office acquired the certification again in June 2008 following its relocation and completion of the renewal procedure.

# Contents



Circular Knitting Needles PRO “Takumi®”	4
Bamboo Knitting Needles Takumi®	7
Crochet Hooks	16
Knitting Accessories	21
Yarn Ball Winder	31
Black Gold Needles	32
Sewing, Quilting & Embroidery Needles	34
Pins	37
Wonder Clips	40
Thimbles	43
Sewing Notions	45
Sewing & Patchwork Accessories	47
Marking Tools	63
Silk Threads	68
Scissors	70
Rotary Cutters	72
Slash Cutter	74
Fabric Tube Maker	75
Tape Makers	76
Mini Iron & Accessories	78
Embroidery Stitching Tools	79
“Kantan Couture ” Bead Embroidery Tools	80
Stitch Dome	81
Punch Needle and Hoop	81
Pom-Pom Makers	82
Tassel Makers	83
“QUICK” Yo-Yo Makers	84
Kanzashi Flower Makers	85
Needle Felting Tools	86
Natural Wool Rovings	87
Swift Bead	87
French Knitter	88
Wonder Knitter	88
Bracelet Maker	89
Flower Loom	89
Beading Loom	90
Beading Loom Kits	91
Mini Weaving Loom	92
Picot Comb	92
Tatting Shuttles	93
Hair Pin Lace Tool	93
Weaving Sticks	94
Macrame Plant Hanger Gauge	94
Trace ‘n Create Templates <i>with Nancy Zieman</i>	94
Wrap ‘n Fuse Piping	94
Rosette Makers	95
Clover Circle ~Where Creativity Never Ends~	96

## Designed for Ultimate Knitting Comfort

*PRO “Takumi” is a series of products that achieves ultimate knitting comfort based on the Takumi line of bamboo knitting needles. Make your knitting life more delightful with PRO “Takumi.”*

### 1. Ideal Tapered Tips

Clover’s high quality bamboo processing technology has achieved the ideal tapered tips which easily pick up stitches and avoids splitting yarn.

### 2. Silky smooth surface without top coat

The careful polishing process creates a smooth surface and natural texture for an ideal glide without your work slipping out.

#### The engraved mark has been improved.

The engraving is now more subtly etched, resulting in a smoother surface that ensures uninterrupted yarn gliding.



### 3. Flexible and relaxed cord

The new and improved cord will not kink or twist.

### 4. Colour-coded tip \*1

Each cord size has a different colored tip, allowing for quick visual identification. The blend of aesthetics and practicality makes it visually appealing and useful.



\* The US 0-2 (2.00-2.75 mm) needle shafts are so thin that only metal fittings are used at the joints.

### 5. Seamless smooth joints

Seamless needle-to-cord joints for smooth gliding without snagging. By reducing the size of the metal component, you can feel the bamboo texture more.

The rich texture of bamboo that only Takumi can offer fits comfortably in your hand.

The stainless steel metal component is both durable and resistant to age-related deterioration.

### 6. Rotating cord \*2

Thanks to the rotating cord, it does not get twisted, allowing you to carry on knitting unhindered.



\*1,2 : U.S. and U.K. Patented / Germany (patent pending)

# Circular Knitting Needles PRO "Takumi"®



3300-3317	
Circular Knitting Needles PRO "Takumi"® (16 in/40 cm)	
Packing	1 pc./pack 3 packs/box
Package Size	7.28 x 3.54 x 0.2 - 0.5 in



3320-3337	
Circular Knitting Needles PRO "Takumi"® (24 in/60 cm)	
Packing	1 pc./pack 3 packs/box
Package Size	8.58 x 3.54 x 0.2 - 0.5 in



3300	16 in	US 0	2.0 mm
0	51221	23300	5

3309	16 in	US 7	4.5 mm
0	51221	23309	8

3320	24 in	US 0	2.0 mm
0	51221	23320	3

3329	24 in	US 7	4.5 mm
0	51221	23329	6

3301	16 in	US 1	2.25 mm
0	51221	23301	2

3310	16 in	US 8	5.0 mm
0	51221	23310	4

3321	24 in	US 1	2.25 mm
0	51221	23321	0

3330	24 in	US 8	5.0 mm
0	51221	23330	2

3302	16 in	US 1 1/2	2.5 mm
0	51221	23302	9

3311	16 in	US 9	5.5 mm
0	51221	23311	1

3322	24 in	US 1 1/2	2.5 mm
0	51221	23322	7

3331	24 in	US 9	5.5 mm
0	51221	23331	9

3303	16 in	US 2	2.75 mm
0	51221	23303	6

3312	16 in	US 10	6.0 mm
0	51221	23312	8

3323	24 in	US 2	2.75 mm
0	51221	23323	4

3332	24 in	US 10	6.0 mm
0	51221	23332	6

3304	16 in	US 2 1/2	3.0 mm
0	51221	23304	3

3313	16 in	US 10 1/2	6.5 mm
0	51221	23313	5

3324	24 in	US 2 1/2	3.0 mm
0	51221	23324	1

3333	24 in	US 10 1/2	6.5 mm
0	51221	23333	3

3305	16 in	US 3	3.25 mm
0	51221	23305	0

3314	16 in	US 10 3/4	7.0 mm
0	51221	23314	2

3325	24 in	US 3	3.25 mm
0	51221	23325	8

3334	24 in	US 10 3/4	7.0 mm
0	51221	23334	0

3306	16 in	US 4	3.5 mm
0	51221	23306	7

3315	16 in	US 11	8.0 mm
0	51221	23315	9

3326	24 in	US 4	3.5 mm
0	51221	23326	5

3335	24 in	US 11	8.0 mm
0	51221	23335	7

3307	16 in	US 5	3.75 mm
0	51221	23307	4

3316	16 in	US 13	9.0 mm
0	51221	23316	6

3327	24 in	US 5	3.75 mm
0	51221	23327	2

3336	24 in	US 13	9.0 mm
0	51221	23336	4

3308	16 in	US 6	4.0 mm
0	51221	23308	1

3317	16 in	US 15	10.0 mm
0	51221	23317	3

3328	24 in	US 6	4.0 mm
0	51221	23328	9

3337	24 in	US 15	10.0 mm
0	51221	23337	1



# Circular Knitting Needles PRO "Takumi®"

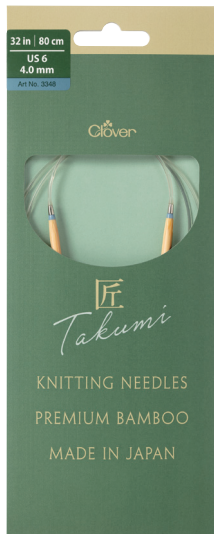

**3340-3357**  
**Circular Knitting Needles PRO**  
**"Takumi®" (32 in/80 cm)**

Packing	1 pc./pack
	3 packs/box
Package Size	8.58 × 3.54 × 0.2 - 0.5 in



3340 32 in US 0 | 2.0 mm

0 51221 23340 1

3346 32 in US 4 | 3.5 mm

0 51221 23346 3

3352 32 in US 10 | 6.0 mm

0 51221 23352 4

3341 32 in US 1 | 2.25 mm

0 51221 23341 8

3347 32 in US 5 | 3.75 mm

0 51221 23347 0

3353 32 in US 10 1/2 | 6.5 mm

0 51221 23353 1

3342 32 in US 1 1/2 | 2.5 mm

0 51221 23342 5

3348 32 in US 6 | 4.0 mm

0 51221 23348 7

3354 32 in US 10 3/4 | 7.0 mm

0 51221 23354 8

3343 32 in US 2 | 2.75 mm

0 51221 23343 2

3349 32 in US 7 | 4.5 mm

0 51221 23349 4

3355 32 in US 11 | 8.0 mm

0 51221 23355 5

3344 32 in US 2 1/2 | 3.0 mm

0 51221 23344 9

3350 32 in US 8 | 5.0 mm

0 51221 23350 0

3356 32 in US 13 | 9.0 mm

0 51221 23356 2

3345 32 in US 2 | 3.25 mm

0 51221 23345 6

3351 32 in US 9 | 5.5 mm

0 51221 23351 7

3357 32 in US 15 | 10.0 mm

0 51221 23357 9

## What Makes Knitting Needles Easy to Knit With?

Unlike crochet hooks, which only use the hook part, straight needles utilize the entire needle when knitting. The key factors for smooth knitting are the needle tip, sliding of the needle shaft, and adherence to accurate standards.

### • Needle tip

The best needle tip has two features: it is easy to insert into stitches and is unlikely to split the yarn. If the needle tip is too sharp, it may be easy to insert into stitches, but it will also tend to split the yarn and hurt the knitter's fingers. Takumi achieves both of the positive features by rounding the tip in the manufacturing process.



Takumi's needle tip

### • Perfect sliding on the needle shaft

Smooth transfer of stitches from the needle tip to the shaft results in uniformly sized stitches and a beautiful fabric. Takumi utilizes the natural properties of bamboo by polishing it to create a needle surface that is both easy to hold and slide. Instead of applying a surface coating, polishing is used to create needles that continue to slide easily and smoothly over time.

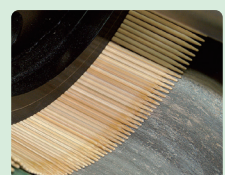

Needle tip polishing process

### • Precision in Standards

To achieve a fabric with neatly aligned stitches, the thickness of the needle shaft must be precise and uniform. A needle too thin for the yarn yields stiff stitches, while one too thick results in coarse stitches. Takumi employs a unique manufacturing process to ensure a uniform shaft diameter.

# Bamboo Knitting Needles Takumi®

The art born from combining the finest raw materials and Clover's unmatched manufacturing technology.

*Each and every one of these high quality bamboo knitting needles has been created utilising the properties of the finest natural materials.*

Takumi Bamboo Knitting Needles have been created with Clover's long-nurtured manufacturing technology which maximizes the qualities of the finest natural bamboo to achieve even a smoother, heartfelt knitting experience. Their smooth surface and comfortable fitting are the result of Clover's consideration for knitters. You will still be able to find these needles comfortable even after long hours of knitting.

Feel and experience these knitting needles made of carefully selected natural bamboo.

*Takumi's supreme quality also comes from Clover's excellent manufacturing technology*

- Excellent durability**  
 Only the finest parts of natural bamboo are used for knitting needles that perform year after year
- Clover's original, ideally shaped needle tip.**  
 Takumi Needles are comfortable to hold and will keep your yarn from splitting.
- Uniform shaft**  
 These needles feature a special finish that make shafts even—promising neat stitches and finishing.
- Smooth surface finish**  
 The surface is carefully finished to fit your hand comfortably and to make sure that yarn glides smoothly along the needles.

Needle size (mm) Actual size

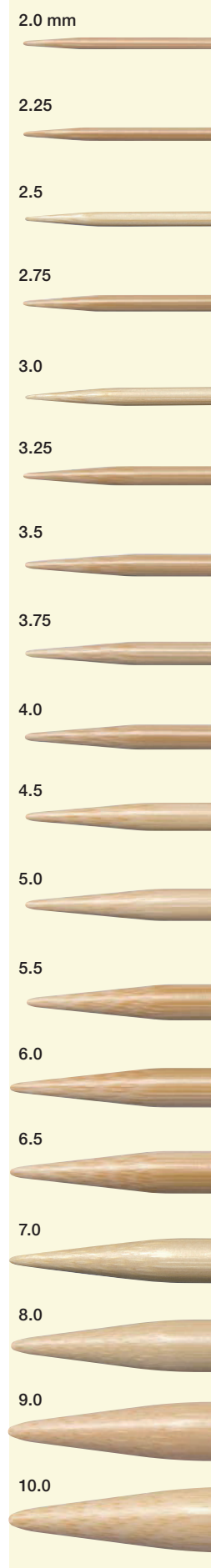

## Bamboo that Becomes Takumi®

### Finest Top Quality Material

Bamboo is a strong, elastic and hardy fiber. Its smooth surface and comfortable fit are the most desirable for knitting needles. Only the most premium parts of the bamboo are used for the needles.

Place of origin is limited to cold areas with little snow.

Bamboo in cold areas with little snow is very resistant to bending making this bamboo most desirable for knitting needles.

Heavy snow conditions result in bent bamboo.

Appropriately aged Bamboo is selected.

Young bamboo less than 3 years old is too soft while bamboo older than 5 years is too fragile. 4 to 5 year old bamboo is the most durable bamboo to use.

Cutting period is limited to winter.

Bamboo in winter has less moisture and the fiber is more compact.



- We do not use bamboo nodes (joints) or the pieces, adjacent to nodes because those woody fibers are not straight enough.

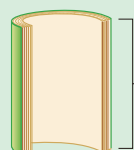

- We use only those bamboo sections between nodes (internodes) that have adequate density.

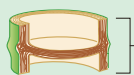

- We cut and discard the bent portions, shoots and roots of bamboo trees.

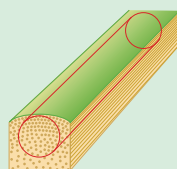

- In order to make sure that materials do not shrink when they are dried, we use only the portion near the outer surface, where wood fiber texture is firm and tight.





# Bamboo Knitting Needles Takumi®

## Bamboo Circular Knitting Needles Takumi®



3016/9-0~8	
Bamboo Circular Knitting Needles "Takumi"® 9 in (23 cm)	
Description	1 pc./pack 3 packs/box
Package Size	7.25 x 2.38 x 0.13-0.25 in.



3016/16-0~15	
Bamboo Circular Knitting Needles "Takumi"® 16 in (41 cm)	
Description	1 pc./pack 3 packs/box
Package Size	
Size 0-3	7.38 x 2.38 x 0.13-0.5 in.
Size 4-15	7.25 x 2.38 x 0.25-0.5 in.

3016/9-0	No. 0 (2.0 mm)
3016/9-1	No. 1 (2.25 mm)
3016/9-2	No. 2 (2.75 mm)
3016/9-3	No. 3 (3.25 mm)
3016/9-4	No. 4 (3.5 mm)

3016/9-5	No. 5 (3.75 mm)
3016/9-6	No. 6 (4.0 mm)
3016/9-7	No. 7 (4.5 mm)
3016/9-8	No. 8 (5.0 mm)

3016/16-0	No. 0 (2.0 mm)
3016/16-1	No. 1 (2.25 mm)
3016/16-2	No. 2 (2.75 mm)
3016/16-3	No. 3 (3.25 mm)
3016/16-4	No. 4 (3.5 mm)
3016/16-5	No. 5 (3.75 mm)
3016/16-6	No. 6 (4.0 mm)
3016/16-7	No. 7 (4.5 mm)

3016/16-8	No. 8 (5.0 mm)
3016/16-9	No. 9 (5.5 mm)
3016/16-10	No. 10 (6.0 mm)
3016/16-10.5	No. 10.5 (6.5 mm)
3016/16-11	No. 11 (8.0 mm)
3016/16-13	No. 13 (9.0 mm)
3016/16-15	No. 15 (10.0 mm)



# Bamboo Knitting Needles Takumi®

## Bamboo Circular Knitting Needles Takumi®



3016/24-0~19	
Bamboo Circular Knitting Needles "Takumi"® 24 in (61 cm)	
Description	1 pc./pack 3 packs/box
Package Size	
Size 0-15	9 x 3.13 x 0.13-0.5 in
Size 17-19	9 x 4.33 x 0.5 in



3016/29-0~19	
Bamboo Circular Knitting Needles "Takumi"® 29 in (74 cm)	
Description	1 pc./pack 3 packs/box
Package Size	
Size 0-4	9 x 3.13 x 0.13-0.25 in
Size 5-15	9.13 x 3.13 x 0.25-0.38 in
Size 17-19	9 x 4.33 x 0.5-0.63 in

3016/24-0 No. 0 (2.0 mm)

0 5 1221 25200 6

3016/24-9 No. 9 (5.5 mm)

0 5 1221 25209 9

3016/29-0 No.0 (2.0 mm)

0 5 1221 25300 3

3016/29-9 No.9 (5.5 mm)

0 5 1221 25309 6

3016/24-1 No. 1 (2.25 mm)

0 5 1221 25201 3

3016/24-10 No.10 (6.0 mm)

0 5 1221 25210 5

3016/29-1 No. 1 (2.25 mm)

0 5 1221 25301 0

3016/29-10 No. 10 (6.0 mm)

0 5 1221 25310 2

3016/24-2 No. 2 (2.75 mm)

0 5 1221 25202 0

3016/24-10.5 No. 10.5 (6.5 mm)

0 5 1221 25211 2

3016/29-2 No. 2 (2.75 mm)

0 5 1221 25302 7

3016/29-10.5 No. 10.5 (6.5 mm)

0 5 1221 25311 9

3016/24-3 No. 3 (3.25 mm)

0 5 1221 25203 7

3016/24-11 No.11 (8.0 mm)

0 5 1221 25212 9

3016/29-3 No. 3 (3.25 mm)

0 5 1221 25303 4

3016/29-11 No. 11 (8.0 mm)

0 5 1221 25312 6

3016/24-4 No. 4 (3.5 mm)

0 5 1221 25204 4

3016/24-13 No.13 (9.0 mm)

0 5 1221 25213 6

3016/29-4 No. 4 (3.5 mm)

0 5 1221 25304 1

3016/29-13 No. 13 (9.0 mm)

0 5 1221 25313 3

3016/24-5 No. 5 (3.75 mm)

0 5 1221 25205 1

3016/24-15 No.15 (10.0 mm)

0 5 1221 25214 3

3016/29-5 No. 5 (3.75 mm)

0 5 1221 25305 8

3016/29-15 No. 15 (10.0 mm)

0 5 1221 25314 0

3016/24-6 No. 6 (4.0 mm)

0 5 1221 25206 8

3016/24-17 No.17 (12.75 mm)

0 5 1221 28215 7

3016/29-6 No. 6 (4.0 mm)

0 5 1221 25306 5

3016/29-17 No. 17 (12.75 mm)

0 5 1221 28315 4

3016/24-7 No. 7 (4.5 mm)

0 5 1221 25207 5

3016/24-19 No.19 (15 mm)

0 5 1221 28216 4

3016/29-7 No. 7 (4.5 mm)

0 5 1221 25307 2

3016/29-19 No. 19 (15 mm)

0 5 1221 28316 1

3016/24-8 No. 8 (5.0 mm)

0 5 1221 25208 2

3016/29-8 No. 8 (5.0 mm)

0 5 1221 25308 9



# Bamboo Knitting Needles Takumi®

## Bamboo Circular Knitting Needles Takumi®



<b>3016/36-0~19</b>	
<b>Bamboo Circular Knitting Needles "Takumi"® 36 in (91 cm)</b>	
Description	1 pc./pack 3 packs/box
Package Size	
Size 0-15	9.13 x 3.13 x 0.25-0.5 in
Size 17-19	9 x 4.33 x 0.5-0.63 in



<b>3016/48-0~10.5</b>	
<b>Bamboo Circular Knitting Needles "Takumi"® 48 in (120 cm)</b>	
Description	1 pc./pack 3 packs/box
Package Size	9 x 3.15 x 0.14 in

**3016/36-0** No. 0 (2.0 mm)

0 5 1221 25330 0

**3016/36-9** No. 9 (5.5 mm)

0 5 1221 25339 3

**3016/48-0** No.0 (2.0 mm)

0 5 1221 25380 5

**3016/48-6** No.6 (4.0 mm)

0 5 1221 25386 7

**3016/36-1** No. 1 (2.25 mm)

0 5 1221 25331 7

**3016/36-10** No.10 (6.0 mm)

0 5 1221 25340 9

**3016/48-1** No. 1 (2.25 mm)

0 5 1221 25381 2

**3016/48-7** No. 7 (4.5 mm)

0 5 1221 25387 4

**3016/36-2** No. 2 (2.75 mm)

0 5 1221 25332 4

**3016/36-10.5** No. 10.5 (6.5 mm)

0 5 1221 25341 6

**3016/48-2** No. 2 (2.75 mm)

0 5 1221 25382 9

**3016/48-8** No. 8 (5.0 mm)

0 5 1221 25388 1

**3016/36-3** No. 3 (3.25 mm)

0 5 1221 25333 1

**3016/36-11** No.11 (8.0 mm)

0 5 1221 25342 3

**3016/48-3** No. 3 (3.25 mm)

0 5 1221 25383 6

**3016/48-9** No. 9 (5.5 mm)

0 5 1221 25389 8

**3016/36-4** No. 4 (3.5 mm)

0 5 1221 25334 8

**3016/36-13** No.13 (9.0 mm)

0 5 1221 25343 0

**3016/48-4** No. 4 (3.5 mm)

0 5 1221 25384 3

**3016/48-10** No. 10 (6.0 mm)

0 5 1221 25390 4

**3016/36-5** No. 5 (3.75 mm)

0 5 1221 25335 5

**3016/36-15** No.15 (10.0 mm)

0 5 1221 25345 4

**3016/48-5** No. 5 (3.75 mm)

0 5 1221 25385 0

**3016/48-10.5** No. 10.5 (6.5 mm)

0 5 1221 25391 1

**3016/36-6** No. 6 (4.0 mm)

0 5 1221 25336 2

**3016/36-17** No.17 (12.75 mm)

0 5 1221 28346 8

**3016/36-7** No. 7 (4.5 mm)

0 5 1221 25337 9

**3016/36-19** No.19 (15 mm)

0 5 1221 28347 5

**3016/36-8** No. 8 (5.0 mm)

0 5 1221 25338 6

# Bamboo Knitting Needles Takumi®

## Bamboo Knitting Needles Takumi® Double Pointed



**3014/0-10.5**  
**Bamboo Knitting Needles**  
**"Takumi"® Double Pointed 5 in**  
**(12.5 cm)**

Description	5 pcs./pack
	3 packs/box
Package Size	
Size 0-7	7 x 1.38 x 0.13 in
Size 8-10.5	7 x 1.8 x 0.1 in



**3015/10-15**  
**Bamboo Knitting Needles**  
**"Takumi"® Double Pointed 7 in**  
**(18 cm)**

Description	5 pcs./pack
	3 packs/box
Package Size	
Size 0-7	9.13 x 1.25 x 0.13 in
Size 8-10.5	9.13 x 1.75 x 0.25 in
Size 11-15	9.25 x 2.25 x 0.38 in



<b>3015/7</b>	No. 7 (4.5 mm)
0 5 1221 22207 8	

<b>3014/0</b>	No. 0 (2.0 mm)
0 5 1221 22120 0	

<b>3014/6</b>	No. 6 (4.0 mm)
0 5 1221 22126 2	

<b>3015/0</b>	No. 0 (2.0 mm)
0 5 1221 22200 9	

<b>3015/8</b>	No. 8 (5.0 mm)
0 5 1221 22208 5	

<b>3014/1</b>	No. 1 (2.25 mm)
0 5 1221 22121 7	

<b>3014/7</b>	No. 7 (4.5 mm)
0 5 1221 22127 9	

<b>3015/1</b>	No. 1 (2.25 mm)
0 5 1221 22201 6	

<b>3015/9</b>	No. 9 (5.5 mm)
0 5 1221 22209 2	

<b>3014/2</b>	No. 2 (2.75 mm)
0 5 1221 22122 4	

<b>3014/8</b>	No. 8 (5.0 mm)
0 5 1221 22128 6	

<b>3015/2</b>	No. 2 (2.75 mm)
0 5 1221 22202 3	

<b>3015/10</b>	No. 10 (6.0 mm)
0 5 1221 22210 8	

<b>3014/3</b>	No. 3 (3.25 mm)
0 5 1221 22123 1	

<b>3014/9</b>	No. 9 (5.5 mm)
0 5 1221 22129 3	

<b>3015/3</b>	No. 3 (3.25 mm)
0 5 1221 22203 0	

<b>3015/10.5</b>	No. 10.5 (6.5 mm)
0 5 1221 22211 5	

<b>3014/4</b>	No. 4 (3.5 mm)
0 5 1221 22124 8	

<b>3014/10</b>	No. 10 (6.0 mm)
0 5 1221 22130 9	

<b>3015/4</b>	No. 4 (3.5 mm)
0 5 1221 22204 7	

<b>3015/11</b>	No. 11 (8.0 mm)
0 5 1221 22212 2	

<b>3014/5</b>	No. 5 (3.75 mm)
0 5 1221 22125 5	

<b>3014/10.5</b>	No. 10.5 (6.5 mm)
0 5 1221 22131 6	

<b>3015/5</b>	No. 5 (3.75 mm)
0 5 1221 22205 4	

<b>3015/13</b>	No. 13 (9.0 mm)
0 5 1221 22213 9	

<b>3015/6</b>	No. 6 (4.0 mm)
0 5 1221 22206 1	

<b>3015/15</b>	No. 15 (10.0 mm)
0 5 1221 22214 6	



# Bamboo Knitting Needles Takumi®

## Bamboo Knitting Needles Takumi® Single Pointed



3011/0-19	
Bamboo Knitting Needles "Takumi"® Single Pointed 9 in (23 cm)	
Description	2 pcs./pack 3 packs/box
Package Size	
Size 0-10.5	11.25 x 1.5 x 0.25 in
Size 11-15	11.25 x 2 x 0.5 in
Size 17-19	12.2 x 2 x 0.87 in



3012/0-15	
Bamboo Knitting Needles "Takumi"® Single Pointed 13 in/14 in (33 cm/36 cm)	
Description	2 pcs./pack 3 packs/box
Package Size	
Size 0-10.5	15.25 x 1.38 x 0.5 in
Size 11-15	16 x 2 x 0.5 in

3011/8	No. 8 (5.0 mm)

3011/0	No. 0 (2.0 mm)

3011/9	No.9 (5.5 mm)

3011/1	No. 1 (2.25 mm)

3011/10	No. 10 (6.0 mm)

3012/0	No. 0 (2.0 mm)

3012/7	No.7 (4.5 mm)

3011/2	No. 2 (2.75 mm)

3011/10.5	No. 10.5 (6.5 mm)

3012/1	No. 1 (2.25 mm)

3012/9	No. 9 (5.5 mm)

3011/3	No. 3 (3.25 mm)

3011/11	No. 11 (8.0 mm)

3012/2	No. 2 (2.75 mm)

3012/10	No. 10 (6.0 mm)

3011/4	No. 4 (3.5 mm)

3011/13	No. 13 (9.0 mm)

3012/3	No. 3 (3.25 mm)

3012/10.5	No. 10.5 (6.5 mm)

3011/5	No. 5 (3.75 mm)

3011/15	No. 15 (10.0 mm)

3012/4	No. 4 (3.5 mm)

3012/11	No. 11 (8.0 mm)

3011/6	No. 6 (4.0 mm)

3011/17	No. 17 (12.75 mm)

3012/5	No. 5 (3.75 mm)

3012/13	No. 13 (9.0 mm)

3011/7	No. 7 (4.5 mm)

3011/19	No. 19 (15.0 mm)

3012/6	No. 6 (4.0 mm)

3012/15	No. 15 (10.0 mm)

# Bamboo Knitting Needles Takumi®

## Bamboo Crochet Hooks Takumi®



<b>3500-3505</b>	
<b>Bamboo Crochet Hooks "Takumi"</b>	

Description	1 pc./pack
	3 packs/box
Package Size	7.87 x 1.57 x 0.15-0.26 in



### What is Different About the Bamboo Used for Takumi?

Takumi carefully selects and uses bamboo that is straight, dense in fibre, and resilient (bend-resistant), which is the optimum material for knitting needles. Takumi exclusively uses bamboo meeting strict standards; other materials can't endure Clover's unique process of sharpening needle tips and polishing for a glossy finish.

- **Bamboo grown in a cold region with little snow**

The fibres are tight and the bamboo is straight because it has not been bent by the weight of snow.

- **Bamboo aged four to five years old**

Younger bamboo is too soft and weak, while older bamboo has brittle fibres.

- **Harvesting is done only during winter**

Winter is drier and has less moisture, making the bamboo less prone to mold.

- **Only the part close to the bamboo bark, where the fibres are dense, is used**

Magnified photo of a cross section of a bamboo knitting needle:

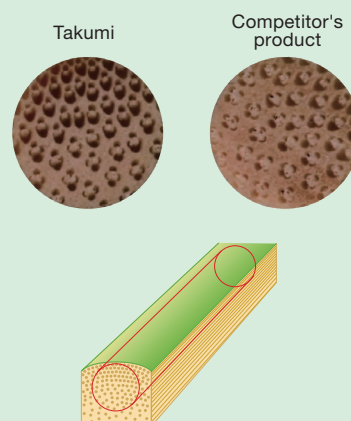

# Bamboo Knitting Needles Takumi®

## "Takumi®" Bamboo Interchangeable Circular Knitting Needles



### 3633-3644 Takumi® Bamboo Interchangeable Circular Knitting Needles

2 pcs./pack	3 packs
Package Size	8.27 x 3.15 x 0.17-0.43 in

<b>3633</b>	
No. 3 (3.25 mm)	0 5 1221 73633 9
<b>3634</b>	
No. 4 (3.5 mm)	0 5 1221 73634 6
<b>3635</b>	
No. 5 (3.75 mm)	0 5 1221 73635 3
<b>3636</b>	
No. 6 (4.0 mm)	0 5 1221 73636 0
<b>3637</b>	
No. 7 (4.5 mm)	0 5 1221 73637 7
<b>3638</b>	
No. 8 (5.0 mm)	0 5 1221 73638 4
<b>3639</b>	
No. 9 (5.5 mm)	0 5 1221 73639 1
<b>3640</b>	
No. 10 (6.0 mm)	0 5 1221 73640 7
<b>3641</b>	
No. 10.5 (6.5 mm)	0 5 1221 73641 4
<b>3642</b>	
No. 11 (8.0 mm)	0 5 1221 73642 1
<b>3643</b>	
No. 13 (9.0 mm)	0 5 1221 73643 8
<b>3644</b>	
No. 15 (10.0 mm)	0 5 1221 73644 5



Combo includes 5 interchangeable cords and 12 tip sizes creating 60 possible combinations of circular knitting needles.

### 3683 "Takumi®" Combo Interchangeable Circular Knitting Needles

1 set/box	
Package Size	10.83 x 6.89 x 1.18 in



### 3645-3649 Interchangeable Cords

1 pcs./ pack	3 packs
Package Size	8.27 x 3.15 x 0.16 in
<b>3645</b>	
16 in (41 cm)	0 5 1221 73645 2
<b>3646</b>	
24 in (61 cm)	0 5 1221 73646 9
<b>3647</b>	
29 in (74 cm)	0 5 1221 73647 6
<b>3648</b>	
36 in (91 cm)	0 5 1221 73648 3
<b>3649</b>	
48 in (120 cm)	0 5 1221 73649 0



### 3652 "Takumi®" Bamboo Interchangeable Circular Knitting Case (Pink)

1 set/box	
Package Size	10.83 x 6.89 x 1.18 in



### 3650 Interchangeable Cord Connectors

2 pcs./pack	3 packs/box
Package Size	7.28 x 2.76 x 0.16 in



# Bamboo Knitting Needles Takumi®

## "Takumi"® Bamboo Interchangeable Tunisian Crochet Hooks



### 3690-3698 Interchangeable Tunisian Crochet Hooks "Takumi"®

1 pcs./ pack	3 packs/box
Package Size	9 x 2.44 x 0.18-0.35 in

<b>3690</b>	
E (3.5 mm)	0 5 1221 73690 2
<b>3691</b>	
F (3.75 mm)	0 5 1221 73691 9
<b>3692</b>	
G (4.0 mm)	0 5 1221 73692 6
<b>3693</b>	
7 (4.5 mm)	0 5 1221 73693 3
<b>3694</b>	
H (5.0 mm)	0 5 1221 73694 0
<b>3695</b>	
I (5.5 mm)	0 5 1221 73695 7
<b>3696</b>	
J (6.0 mm)	0 5 1221 73696 4
<b>3697</b>	
K (6.5 mm)	0 5 1221 73697 1
<b>3698</b>	
L (8.0 mm)	0 5 1221 73698 8

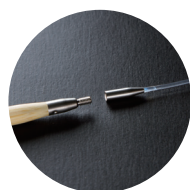

### 3651 Interchangeable Stoppers

0 5 1221 73651 3

2 pcs./pack	3 packs/box
Package Size	7.28 x 2.76 x 0.59 in



### Art. No. 3684 Interchangeable Tunisian Crochet Hook "Takumi"® Combo Set

0 5 1221 73684 1

1 pcs./pack	3 packs/box
Package Size	9.25 x 7 x 1.38 in

Set includes 9 sizes, 5 different interchangeable cords, and 5 cord stoppers.



# Crochet Hooks

## Double Ended Tunisian Crochet Hook

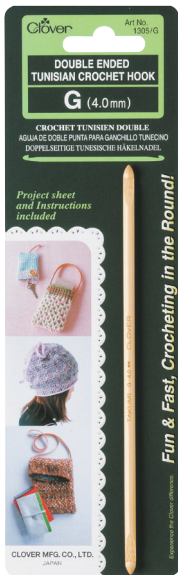

<b>1305/G -1308/J</b>	
<b>Double Ended Tunisian Crochet Hook</b>	
1 pc./pack	3 packs/box
Package Size	8.25 x 2.88 x 0.25 in
<b>1305/G</b>	
<b>G (4.0 mm)</b>	0 51221 11805 0
<b>1306/H</b>	
<b>H (5.0 mm)</b>	0 51221 11806 7
<b>1307/I</b>	
<b>I (5.5 mm)</b>	0 51221 11807 4
<b>1308/J</b>	
<b>J (6.0 mm)</b>	0 51221 11808 1



### Fun & Fast, Crocheting in the Round! Simply work in the round using the 2 hooks and alternating the 2 yarns.

#### • Example of circular knitting

Simply work in rounds in a spiral using the two hooks and alternating the two yarns. It's easy to use and you can knit non-stop.



Use two yarns and knit alternatively. The crocheted fabric is circular.

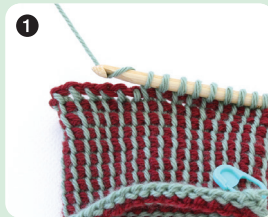

1 Pick up the stitch (the warp yarn of the preceding row or the back bump of chain stitch) with the left hook.



2 Use the right hook to stitch the other yarn and continue.

Enjoy different designs by combining yarns of different colours.

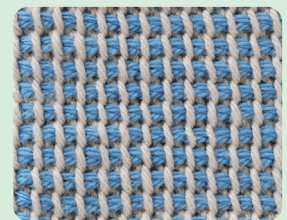

Plain Tunisian stitch

#### • Example of flat knitting



1 Pick up the stitch (the warp yarn of the preceding row or the back bump of chain stitch) with the left hook.

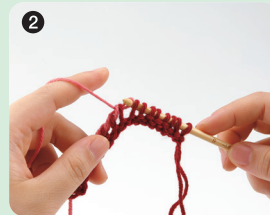

2 Pull up the yarn through the stitches from the left to the right.



3 Repeat 1 and 2.



# Crochet Hooks

## Soft Touch Crochet Hooks

*The sophisticated design gives you the best crocheting experience*

With these easy, soft-touch grips, your hands won't feel fatigue after long hours of crocheting.

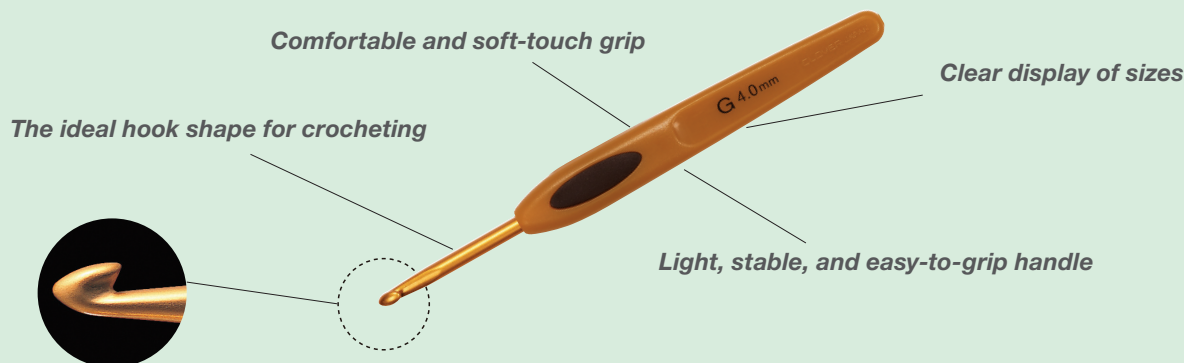

1002/B-1010/J, 1032/7 Soft Touch Crochet Hook	
1 pc./pack	3 packs/box
Package Size	7.5 x 1.5 x 0.5 in
1002/B	
B (2.25 mm)	0 5 1221 11452 6
1003/C	
C (2.75 mm)	0 5 1221 11410 6
1004/D	
D (3.25 mm)	0 5 1221 11411 3
1005/E	
E (3.5 mm)	0 5 1221 11412 0
1006/F	
F (3.75 mm)	0 5 1221 11413 7
1007/G	
G (4.0 mm)	0 5 1221 11414 4
1008/H	
H (5.0 mm)	0 5 1221 11415 1
1009/I	
I (5.5 mm)	0 5 1221 11416 8
1010/J	
J (6.0 mm)	0 5 1221 11417 5
1032/7	
7 (4.5 mm)	0 5 1221 11455 7



1020-1027 Soft Touch Crochet Hook	
1 pc./pack	3 packs/box
Package Size	7.5 x 1.63 x 0.5 in
1020	
No. 0 (1.75 mm)	0 5 1221 11430 4
1021	
No. 2 (1.50 mm)	0 5 1221 11431 1
1022	
No. 4 (1.25 mm)	0 5 1221 11432 8
1023	
No. 6 (1.00 mm)	0 5 1221 11433 5
1024	
No. 8 (0.90 mm)	0 5 1221 11434 2
1025	
No. 10 (0.75 mm)	0 5 1221 11435 9
1026	
No. 12 (0.60 mm)	0 5 1221 11436 6
1027	
No. 14 (0.50 mm)	0 5 1221 11437 3

# Crochet Hooks

## Amour Crochet Hooks

*Amour Crochet Hooks are so comfortable to use that you won't want to stop.*

With a soft, ergonomic handle and an ultra-smooth hook and shaft, crochet is always smooth and even.



### Why Amour Crochet Hooks are the Best Choice:

- *Carefully designed hook*
- *Easy to pull the yarn through the stitches and the stitches stay on the hook*

Stitches don't slip off the hook making it easy to pick up stitches and pull the yarn through the stitches.

It is designed to make basic crocheting smooth and accurate.

<When picking up stitches>



The small hook passes through the stitches easily

<When pulling the yarn through the stitches>



The deep hook holds the yarn securely

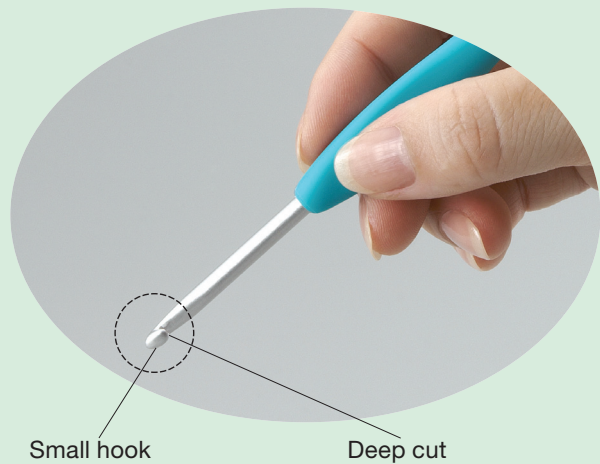

- *Hand-friendly grip*
- *3D design achieves an easy grip*

Grips with a 3D curve fit your fingertips comfortably. These perfectly fitting handles require no extra power, allowing you to knit tirelessly.

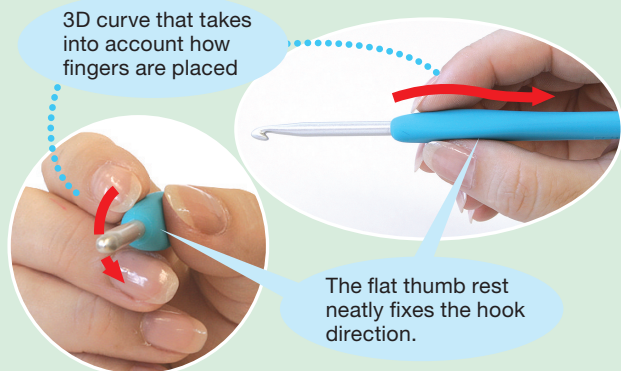

- *Soft and nonslip material*

The entire grip is made of nonslip material to serve many different crocheting styles. It has a comfortable and soft touch.

# Crochet Hooks



1040/B      1041/C      1042/D      1043/E      1044/F



1045/G      1046/7      1047/H      1048/I      1049/J



1053/K      1054      1055/L      1056/MN      1057/NP



1058      1059/PQ



3672

1040/B-1049/J	
Amour Crochet Hook	
1 pc./pack	3 packs/box
Package Size	7.87 x 1.6 x 0.45 in
<b>1040/B</b>	
<b>B (2.25 mm)</b>	0 51221 71040 7
<b>1041/C</b>	
<b>C (2.75 mm)</b>	0 51221 71041 4
<b>1042/D</b>	
<b>D (3.25 mm)</b>	0 51221 71042 1
<b>1043/E</b>	
<b>E (3.5 mm)</b>	0 51221 71043 8
<b>1044/F</b>	
<b>F (3.75 mm)</b>	0 51221 71044 5
<b>1045 G</b>	
<b>G (4.0 mm)</b>	0 51221 71045 2
<b>1046/7</b>	
<b>7 (4.5 mm)</b>	0 51221 71046 9
<b>1047/H</b>	
<b>H (5.0 mm)</b>	0 51221 71047 6
<b>1048/I</b>	
<b>I (5.5 mm)</b>	0 51221 71048 3
<b>1049/J</b>	
<b>J (6.0 mm)</b>	0 51221 71049 0

1053-1059	
Amour Crochet Hook	
1 pc./pack	3 packs/box
Package Size	
Size K-NP	8 x 1.5 x 1 in
Size 12.0 mm-PQ	8.66 x 2 x 0.9 in
<b>1053/K</b>	
<b>K (6.5 mm)</b>	0 51221 71053 7
<b>1054</b>	
<b>7.0 mm</b>	0 51221 71054 4
<b>1055/L</b>	
<b>L (8.0 mm)</b>	0 51221 71055 1
<b>1056/ MN</b>	
<b>MN (9.0 mm)</b>	0 51221 71056 8
<b>1057/NP</b>	
<b>NP (10.0 mm)</b>	0 51221 71057 5
<b>1058</b>	
<b>12.0 mm</b>	0 51221 71058 2
<b>1059/PQ</b>	
<b>PQ (15.0 mm)</b>	0 51221 71059 9

3672	
Amour Crochet Hook Set	
1 set/box	
Package Size	7.5 x 4.33 x 1 in

# Crochet Hooks

<b>1220-1226</b>	
<b>Amour Crochet Hook</b>	
1 pc./pack	3 packs/box
Package Size	7.87 x 1.6 x 0.45 in
<b>1220</b>	
No. 0 (1.75 mm)	
<b>1221</b>	
No. 2 (1.50 mm)	
<b>1222</b>	
No. 4 (1.25 mm)	
<b>1223</b>	
No. 6 (1.00 mm)	
<b>1224</b>	
No. 8 (0.90 mm)	
<b>1225</b>	
No. 10 (0.75 mm)	
<b>1226</b>	
No. 12 (0.60 mm)	
<b>3675</b>	
<b>Amour Crochet Hook Set</b>	
1 set/box	
Package Size	7.6 x 4 x 1.1 in

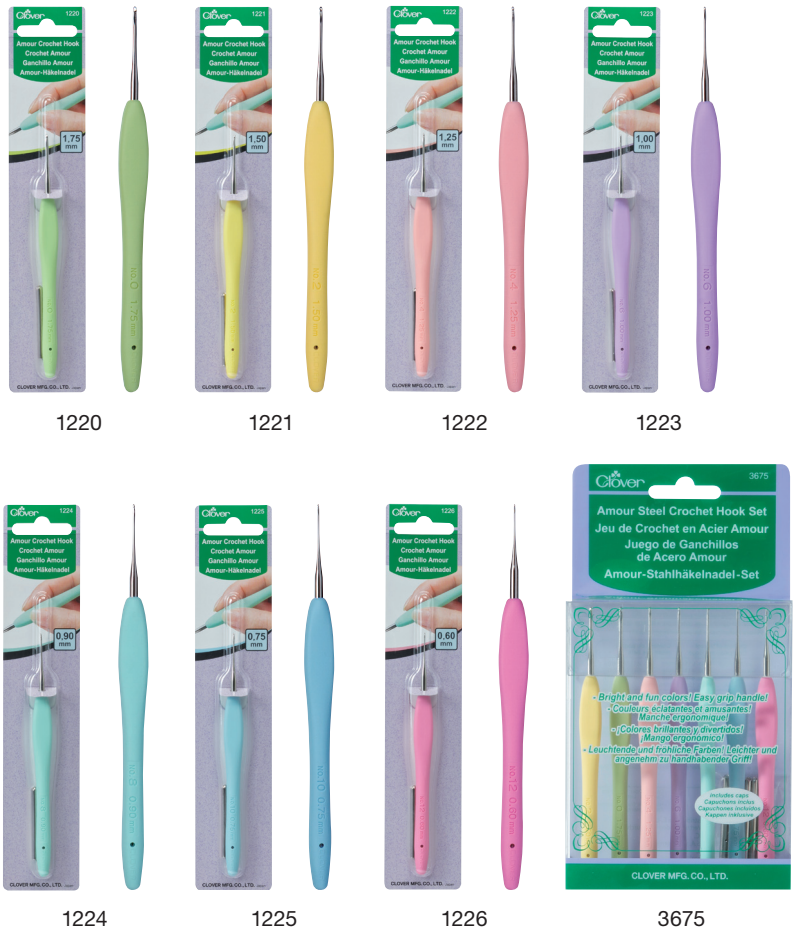

## Why Amour Crochet Hooks are the best choice:

### 1. Easy-to-Use Crochet Hook

The hook is designed to prevent thread from slipping, and making picking up and pulling through of stitches easier.

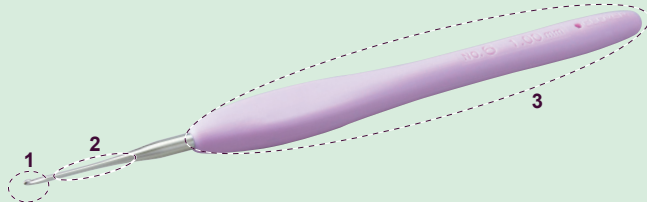
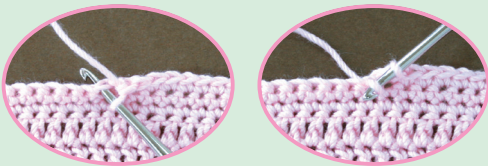

### 2. Soft, non-slip material is easy to grip reducing hand fatigue.

The three-dimensional curves on the grip fit your fingertips naturally. This naturally fitting design prevents you from gripping the needle unnecessarily tightly, stopping your hand from getting tired easily.

### 3. Beautiful even stitches because of long, uniform diameter shafts.

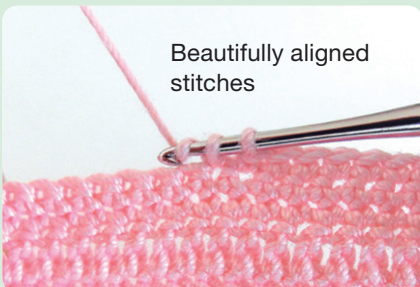

Beautifully aligned stitches

Uniform thickness of the wider part of the shaft will keep the stitches neatly aligned.



Neat and beautiful even with many yarn overs

Stitches with many yarn overs can be made beautifully as well.

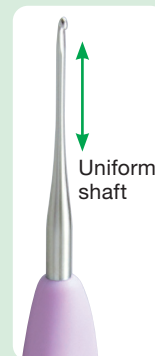

Uniform shaft

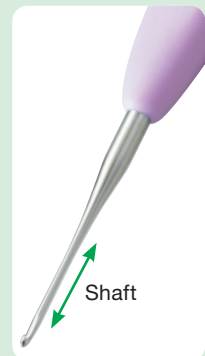

Shaft

# Knitting Accessories

## For repairing and correcting stitches

“Repair Hook” for fixing incorrect knitted stitches



**3009**  
**Bamboo Knitting Repair Hooks**

2 pcs./pack	3 packs/box
Package Size	6.30 x 3.15 x 0.2 in

This set contains hooks of two different sizes to serve a variety of situations.

3/16 in. (4.5 mm) x 4 in. (10 cm)  
 1/8 in. (3.5 mm) x 4 in. (10 cm)

• Made with “Takumi” quality bamboo

Quickly repair with a smoothly finished surface.

Sharp needle tips that easily undo stitches

1/8 in.



Sharp hook tips that easily pass through stitches

3/16 in.

Bamboo will prevent the hook from slipping down, even if you accidentally let go of it.

• For cast-on stitches and pick-up stitches

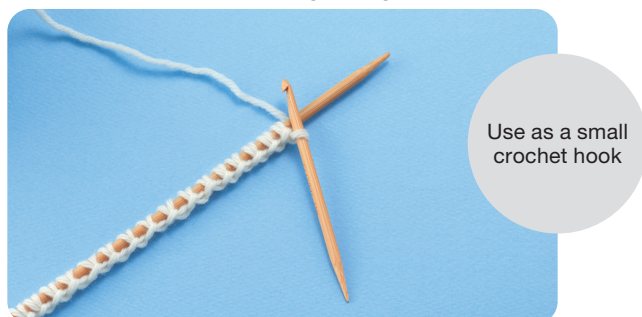

• For detangling yarns such as mohair



Use the sharp point end to unravel stitches as needed and the hook end to pick up new stitches.

## Threader made specially for knitting yarn

Thread darning needles easily.

This plate-like solid threader with a large hole is very convenient when using threads that are difficult to thread, such as hard-twist lace thread and fancy yarn.



**3142**  
**Clover Yarn Threader**

1 pc./pack	3 packs/box
Package Size	5.1 x 2.5 x 0.3 in

Thread yarns easily!



**3114**  
**Antique Yarn Threader**

1 pc./pack	3 packs/box
Package Size	5.1 x 2.8 x 0.4 in

Antique designed threader for yarn and cotton lace.

# Knitting Accessories

## "To Finish"

Darning needles are essential for hand-knitting, including darning and grafting.

Yarn-friendly darning needles that prevent yarns from splitting with their rounded tips.

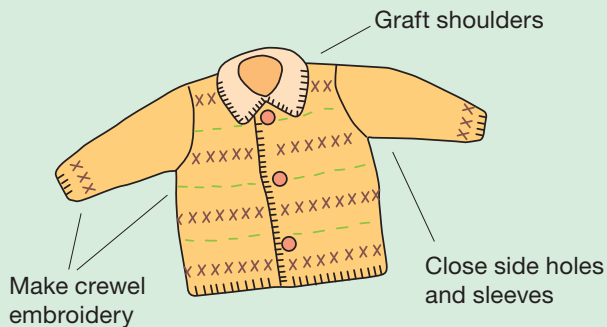

219

**Jumbo Tapestry Needles Bent Tip**



2 needles/pack 5 packs/box  
Package Size 5.8 x 2 x 0.1 in

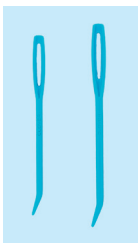

3113

**Super Jumbo Tapestry Needle Set**



2 needles/pack 3 packs/box  
Package Size 6.13 x 2 x 0.13 in

Large eye makes for easy threading of long-pile or extremely thick woolen yarn.

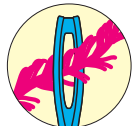

The tip of the needle is slightly curved, making it easier to pick up stitches.

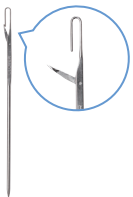

3160

**Darning Needles with Latch Hook Eye**



2 needles/pack 3 packs/box  
Package Size 5.12 x 2.56 x 0.12 in

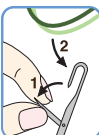

Hook allows for easy threading of multi-ply and bulky yarns.



339

**Darning Needle Set**



3 needles/pack 3 packs/box  
Package Size 6.13 x 2.13 x 0.75 in

A darning needle set in a cute knitting needle shaped case.

Needle sizes:  
No. 13, 17, 20



340

**Jumbo Darning Needle Set**



2 needles/pack 3 packs/box  
Package Size 6 x 2.13 x 0.5 in

A darning needle set in a cute knitting needle shaped case.

Needle size: 2.50 x 70.0 mm



3121

**Darning Needle Set (Bent tip)**



3 needles/pack 3 packs/box  
Package Size 6.13 x 2.13 x 0.75 in

A darning needle set in a cute knitting needle shaped case.

Needle sizes:  
No. 15 (2 pcs.), No. 17 (1 pc.)



3168

**Lace Darning Needle Set**



3 pcs./pack 3 packs/box  
Package Size 6.3 x 2.1 x 0.8 in

Easy and convenient carrying case with a screw on cap stores needles neatly.

Needle sizes:  
No. 20, 22 (Bent tip) / No. 24

# Knitting Accessories



**325**  
**Marking Pins for Knitting**



10 pins/pack      3 packs/box  
Package Size      5.1 x 2.9 x 0.375 in

Marking pins with a blunt tip will not split yarns.



**3143**  
**Bamboo Marking Pins**



10 pins/pack      3 packs/box  
Package Size      7.56 x 2.75 x 0.28 in

Long marking pin for thick knitted fabrics.

Length: Approx. 7 cm (2.75 in.)

Pins made from the same materials as the Bamboo Knitting Needles "Takumi".



**3163**  
**Fork Blocking Pins**



40 pins./pack      3 packs/box  
Package Size      5.12 x 2.95 x 0.63 in

U-Pin for secure pinning and easy removal. Iron smoothly with fork-shared curved pins.

**Hold fabrics temporarily with marking pins before finishing with a mattress stitch or by grafting.**

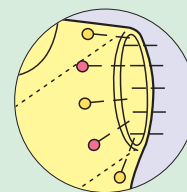

Large head keeps the pin in place

Long shaft makes it easy for you to pin thick fabrics

Rounded tip prevents yarns from splitting

Pin and hold fabrics before closing side holes, grafting shoulder parts and connecting sleeves. Use special marking pins for knitting which are long and have a rounded tip.

**Block knitted garments and sleeves by steaming**

Place and pin the knitted fabric on an ironing board and steam. Leave some space (2-3 cm) between the iron and the fabric while steaming.

Stitches and rounded edges will have a neat and beautiful finish.

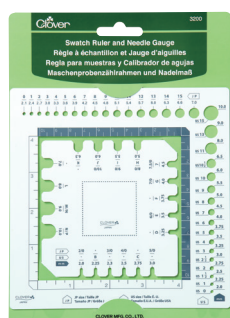
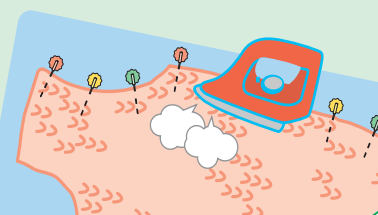

**3200**  
**Swatch Ruler and Needle Gauge**



1 pc./pack      3 packs/box  
Package Size      8.66 x 6.38 x 0.06 in

Measure your crochet hook or knitting needle size in US, metric and Japanese standard sizes.

The Swatch Ruler allows you to isolate a section of your work to easily count both stitches and rows.

*A multi-purpose tool for knitting and crochet.*

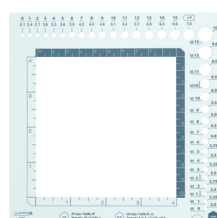

Knitting needle gauge

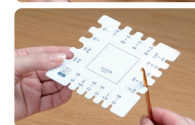

Crochet hook gauge



Swatch ruler



**3147**  
**Knitting Needle Gauge**



1 pc./pack      3 packs/box  
Package Size      5.13 x 3.88 x 0.06 in

Measures 20 needles sizes.  
Needle size: 0-19

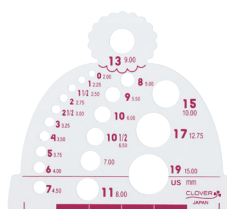

# Knitting Accessories



## 3202 Universal Knitting Counter



1 pc./pack	3 packs/box
Package Size	5.12 x 2.56 x 0.67 in

For circular needles and straight needles!

Easy-to-see numbers and an easy-to-turn dial make the counter section a breeze to use.

The loop can turn 360°, allowing you to turn the dial at a natural angle and meaning it won't become twisted while you're using it.



Can fit: Circular & Straight needles No. 0 – No. 15 (2.0 mm – 10.0 mm)



## 328 Knitting Register



1 pc./pack	3 packs/box
Package Size	5 x 2 x 0.8 in

A convenient register that can be inserted onto a straight knitting needle.

Can fit: Straight needles No. 0 – No. 10 1/2 (2.0 mm – 6.5 mm)

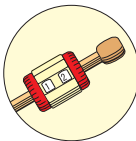

## 348 Yarn Guide



1 pc./pack	3 packs/box
Package Size	5.13 x 2.16 x 0.78 in

A convenient ring type yarn guide.

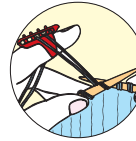

## 349 Yarn Guide (Large)



1 pc./pack	3 packs/box
Package Size	5.13 x 2.16 x 0.62 in

Passing the yarn through the guide allows you to smoothly separate and knit two or more yarns for stranded knitting or color work. The cover can be opened and closed for easy insertion and removal of yarn. There is no need to worry about yarn slipping off during knitting.



Easy-to-fit open ring  
Inner diameter when open:  
approx. 1.75-1.875 in (45-48 mm)



## 3118 Mini Knitting Counter



1 pc./pack	3 packs/box
Package Size	6.3 x 2.76 x 0.39 in

Track the number of knitted stitches and rows.

Pendant style counter.



## 3105 Yarn Cutter Pendant (Antique Gold)



## 3106 Yarn Cutter Pendant (Antique Silver)



1 pc./pack	3 packs/box
Package Size	4.88 x 2.5 x 0.25 in

Yarn can be cut using any of the grooves.

Rotary cutting blade is integrated with pendant, making it safe to use.

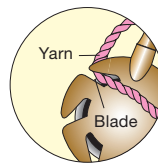

## 336 Knitting Counter



1 pc./pack	3 packs/box
Package Size	5.12 x 2.6 x 0.6 in

Track the number of knitted stitches and rows with a push of a button.





# Knitting Accessories

## Knit with markings

Are you counting stitches and rows over and over again? Count no more by simply placing these markers every 10-20 rows or where you have increased or decreased stitches. Then place stitch ring markers at the beginning of patterns for a smooth knitting experience.

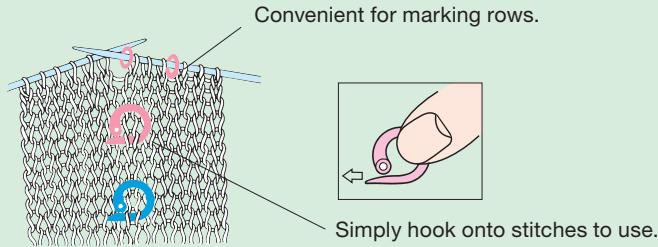

**347**  
**Split Ring Markers**

24 pcs./pack	3 packs/box
Package Size	5.13 x 2.5 x 0.25 in

Securely locks onto knitted stitches. One-touch action for placement and removal.

The round plastic rings in two sizes are slipped on the needles to mark the beginning and ending of pattern stitches, increasing, decreasing on the garment.

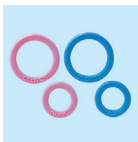

**329**  
**Stitch Ring Markers**

10 small, 20 large rings/pack	3 packs/box
Package Size	5 x 2.5 x 0.25 in

Small for needle size: 0 - 5  
 Large for needle size: 5 - 11

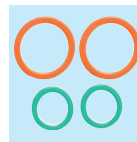
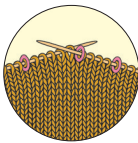

**354**  
**Jumbo Stitch Ring Markers**

10 small, 10 large rings/pack	3 packs/box
Package Size	5 x 2.5 x 0.25 in

A thin ring marker for uniform knitting.  
 Small for needle size: 11 - 15  
 Large for needle size: 17 - 35

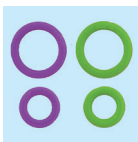
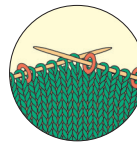

**3107**  
**Soft Stitch Ring Markers**

10 small, 20 large rings/pack	3 packs/box
Package Size	5 x 2.5 x 0.13 in

Small for needle size: 0 - 5  
 Large for needle size: 5 - 11

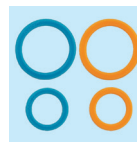
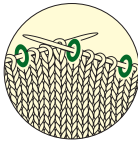

**3108**  
**Soft Jumbo Stitch Ring Markers**

10 small, 20 large rings/pack	3 packs/box
Package Size	5 x 2.5 x 0.13 in

Small for needle size: 11 - 15  
 Large for needle size: 17 - 35

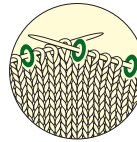

The Stitch Markers Triangle have a specific triangle shape that allows the knitting needle tips to slip in easily when passing the markers from one needle to another.



**3148**  
**Stitch Markers Triangle (XS)**

24 pcs./pack	3 packs/box
Package Size	5.13 x 3.88 x 0.06 in

Needle size: 0 - 4



**3149**  
**Stitch Markers Triangle (Small)**

16 pcs./pack	3 packs/box
Package Size	5.13 x 3.88 x 0.06 in

Needle size: 5 - 18



**3150**  
**Stitch Markers Triangle (Medium)**

16 pcs./pack	3 packs/box
Package Size	5.13 x 3.88 x 0.06 in

Needle size: 9 - 10 1/2



# Knitting Accessories

## Quick Locking Stitch Markers

### Lock-type stitch marker.

It can also be used in the unlocked position. Its undulated design prevents stretching of knitted stitches.



The small size is perfect for fine stitching on socks and laces.



The medium size is ideal for a wide range of projects including accessories and clothes.



The large size is suitable for Cowichan and fancy yarns in which medium-sized markers might be buried.

**3030**

### Quick Locking Stitch Markers (Small)



0 51221 73030 6

20 pcs./pack

3 packs/box

Package Size

5.12 x 2.56 x 0.16 in

**3031**

### Quick Locking Stitch Markers (Medium)



0 51221 73031 3

20 pcs./pack

3 packs/box

Package Size

5.12 x 2.56 x 0.2 in

**3032**

### Quick Locking Stitch Markers (Large)



0 51221 73032 0

12 pcs./pack

3 packs/box

Package Size

5.12 x 2.56 x 0.24 in

**Lock-type stitch marker.**  
It can also be used in the unlocked position. Its undulated design prevents stretching of knitted stitches. Handy compact case included. Small: 10 pcs./Medium: 20 pcs./Large: 6 pcs.

**Basic accessories in handy compact case.**  
A convenient starter set with knitting accessories that you'll use frequently.  
- Quick Locking Stitch Markers (10 pcs.)  
- Soft Stitch Ring Markers (Small: 20 pcs./Large: 20 pcs.)  
For needle sizes:  
Small: 2.0 mm – 3.75 mm  
Large: 3.75 mm – 8.0 mm  
- Point Protectors (2 pcs.)  
For needle sizes: 3.75 mm – 6.5 mm

**Useful basic accessories for sock knitting with case.**  
- Quick Locking Stitch Markers (10 pcs.)  
- Soft Stitch Ring Markers (20 pcs.)  
For needle sizes 2.0 mm – 3.75 mm  
- Double Pointed Needle Protectors (2 pcs.)  
For needle sizes: 2.0 mm – 3.75 mm  
- Darning needles: No. 20, 21



**3033**

### Quick Locking Stitch Marker Set



0 51221 73033 7

1 set/pack

3 packs/box

Package Size

6.3 x 3.94 x 0.91 in



**3034**

### Knitting Accessory Set for Beginners



0 51221 73034 4

1 set/pack

3 packs/box

Package Size

6.3 x 3.94 x 0.91 in



**3035**

### Knitting Accessory Set for Socks



0 51221 73035 1

1 set/pack

3 packs/box

Package Size

6.3 x 3.94 x 0.91 in

## Lock-type stitch marker that stays in place for worry-free knitting

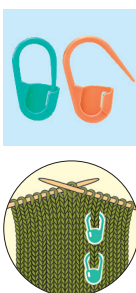

**353**

### Locking Stitch Markers



0 51221 35604 9

20 pcs./pack

3 packs/box

Package Size

5.13 x 2.5 x 0.38 in

Locks onto knitted stitches for worry-free knitting.

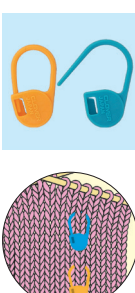

**3109**

### Jumbo Locking Stitch Markers



0 51221 35302 4

12 pcs./pack

3 packs/box

Package Size

5 x 2.5 x 0.5 in

Perfect for super bulky yarn.

# Knitting Accessories



**3165**  
**Locking Stitch Markers with Clip**

6 pcs./pack	3 packs/box
Package Size	6.38 x 3.15 x 0.39 in

- You can attach notes to stitches!
- Perforated notepad included.

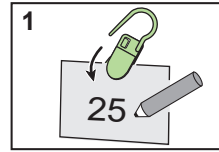

1. Write a note and clip it.

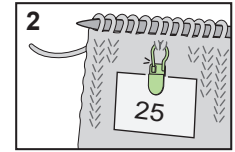

2. Attach to a stitch.

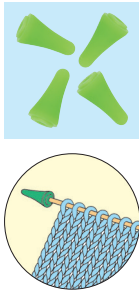

**333/S**  
**Point Protectors (Small)**

4 pcs./pack	3 packs/box
Package Size	4.88 x 2.5 x 0.38 in

A knitting needle cap to prevent knitted stitches from falling off.  
 Needle size: 0-7

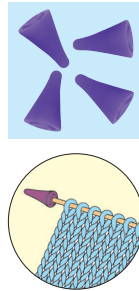

**333/L**  
**Point Protectors (Large)**

4 pcs./pack	3 packs/box
Package Size	5 x 2.5 x 0.63 in

A knitting needle cap to prevent knitted stitches from falling off.  
 Needle size: 6-10 1/2

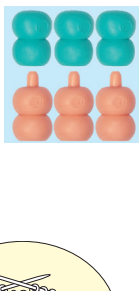

**3140**  
**Point Protectors and Stopper**

6 pcs./pack	3 packs/box
Package Size	5 x 2.5 x 0.5 in

3 pairs of knitting needle caps to prevent stitches from falling off.  
 Cap colours tell you which side of the fabric you are working on!  
 Needle size: 0-10 1/2



**3141**  
**Point Protectors Petit**

4 pcs./pack	3 packs/box
Package Size	5 x 2.5 x 0.5 in

2 pairs of caps that prevents knitted stitches from slipping off. Light and easy to use!  
 Needle size: 0-10 1/2

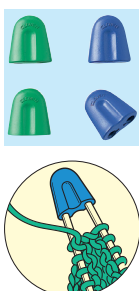

**3004**  
**Point Protector for Circular Knitting Needles (Small)**

4 pcs./pack	3 packs/box
Package Size	5 x 2.5 x 0.25 in

Compactly stores without spreading needles.  
 Needle size: 0-8

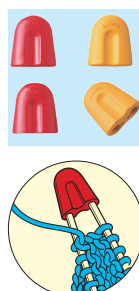

**3005**  
**Point Protector for Circular Knitting Needles (Large)**

4 pcs./pack	3 packs/box
Package Size	5 x 2.5 x 0.25 in

Compactly stores without spreading needles.  
 Needle size: 8-15

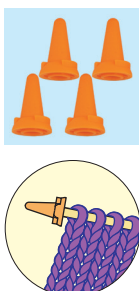

**3110**  
**Jumbo Point Protectors (Small)**

4 pcs./pack	3 packs/box
Package Size	5.13 x 2.75 x 0.88 in

A knitting needle cap to prevent knitted stitches from falling off.  
 Needle size: 11-15



**3112**  
**Jumbo Point Protectors (Large)**

2 pcs./pack	3 packs/box
Package Size	5.12 x 2.76 x 1.1 in

Prevents stitches from slipping off knitting needle.  
 For needle sizes: 17-19

# Knitting Accessories

To transfer stitches onto the Double-Ended Stitch Holder, remove either end cap of the elastic band from the double-point needle, slip stitches onto the Holder, then replace the end cap.

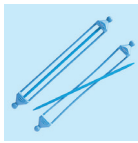

Length:  
5 ¼ in

**351**  
**Double-Ended Stitch Holder (Small)**



2 pcs./pack	3 packs/box
Package Size	7.6 x 2 x 0.4 in
Needle size: 2 - 7 (2.75 - 4.5 mm)	

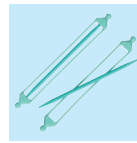

Length:  
5 ¼ in

**3006**  
**Double-Ended Stitch Holder (Medium)**



2 pcs./pack	3 packs/box
Package Size	7.63 x 1.88 x 0.25 in
Needle size: 5 - 11 (3.75 - 8.0 mm)	

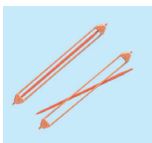

Length:  
6 ½ in

**352**  
**Double-Ended Stitch Holder (Large)**



2 pcs./pack	3 packs/box
Package Size	8.63 x 1.88 x 0.25 in
Needle size: 5 - 11 (3.75 - 8.0 mm)	

The extended length is suitable for works with many stitches.

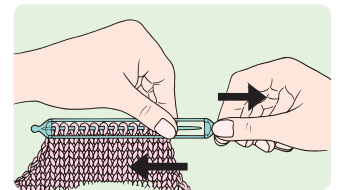
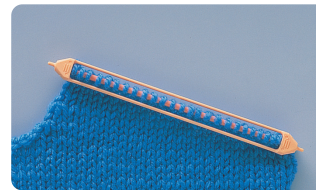

Position the cap so that it won't get in the way while grafting (for large and jumbo sized needles).

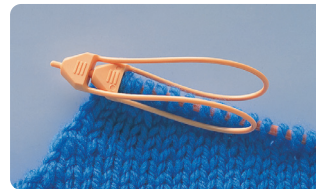

Stitch holder with soft, pliable cord is a convenient way to store your circular work. Keeps the shape without compromising the stitches. Length of cord is adjustable depending on the number of stitches to be held.



**3161**  
**Circular Stitch Holder (Short)**



1 pc./pack	3 packs/box
Package Size	5.12 x 3.94 x 0.47 in

For Circular Knitting Needles:  
9 - 16 in



**3162**  
**Circular Stitch Holder (Long)**



1 pc./pack	3 packs/box
Package Size	5.12 x 3.94 x 0.47 in

For Circular Knitting Needles:  
24 - 36 in



**3003**  
**Knitting Accessory Set**



1 set/pack	3 packs/box
Package Size	8.25 x 4.31 x 0.75 in

Basic knitting tools in handy compact case.

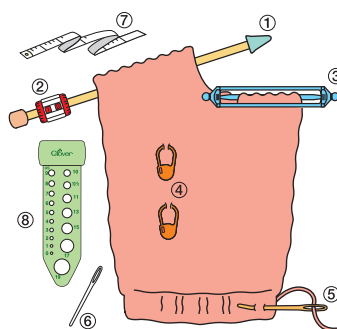

- Set contains:
- ① Point Protectors (Large): 2 pcs.
  - ① Point Protectors (Small): 2 pcs.
  - ② Knitting Register: 1 pc.
  - ③ Double-Ended Stitch Holders (Small): 2 pcs.
  - ④ Locking Stitch Makers: 20 pcs.
  - ⑤ Jumbo Tapestry Needle: 1 pc.
  - ⑥ Tapestry Needle (No. 17): 1 pc.
  - ⑦ Tape Measure (1.5 m): 1 pc.
  - ⑧ Knitting Needle Gauge: 1 pc.

# Knitting Accessories

For Aran patterns and other cross stitches

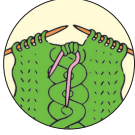

**341**  
Cable Stitch Holders  
(U-Shaped)



3 pcs./pack	3 packs/box
Package Size	6.13 x 1.88 x 0.25 in

Designed to hold stitches at the U-shaped area. For regular size yarns.

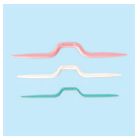

**330**  
Cable Stitch Holders



3 pcs./pack	3 packs/box
Package Size	6.25 x 1.5 x 0.13 in

Standard type for smooth knitting.  
Content: Large, Medium, Small 1 each.

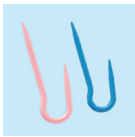

**3008**  
Jumbo Cable Stitch Holder Set  
"U"



2 pcs./pack	3 packs/box
Package Size	6.75 x 2.13 x 0.25 in

Cable Stitch Holder for ultra thick yarns.  
U-shaped design prevents stitches from dropping.

Small: 8 - 10 mm  
Large: 10 - 15 mm

## Knitting Bobbin Set

The Knitting Bobbins are used in keeping yarns from tangling. Yarn is fastened to the bobbin hook. Convenient for knitting with multi-colored yarns.

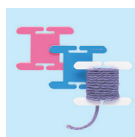
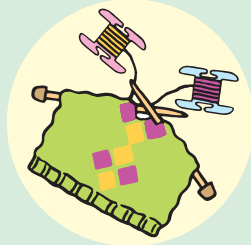

**332**  
Knitting Bobbin Set



6 pcs./pack	3 packs/box
Package Size	5 x 2.5 x 0.31 in

Convenient for knitting with multi-colored yarns.

## Knit patterns

Aran sweaters with many cable and cross stitches, and Fair Isle sweaters with braids using two yarns are excellent in both design and heat-retention.

Try our convenient tools!

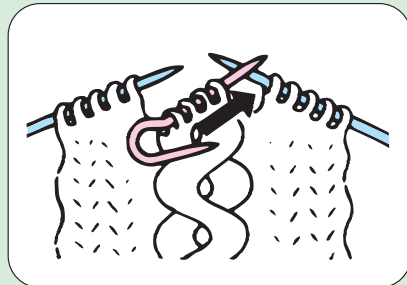
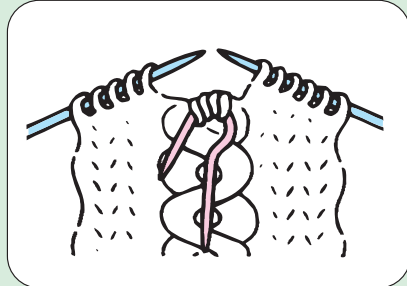

**3164**  
Pattern Chart Marker Set



1 set/pack	3 packs/box
Package Size	14.37 x 4.57 x 0.1 in

- Slip the Pattern Chart Marker onto the chart and hold in place with the attached magnet. Chart Marker moves easily to the next row as you work your pattern.
- You can use it as a book-mark for books or magazines.

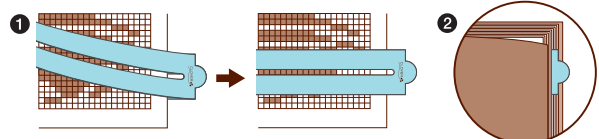

# Knitting Accessories

Convenient for storing needles!

## Convenient coil-style knitting needle holder

*Perfect for storing and carrying around*

Neatly bundle knitting needles and circular needles that are hard to organize. Convenient for storing and carrying around.



**Use different colors to distinguish between needles**

Use a different color depending on the needle size and length.

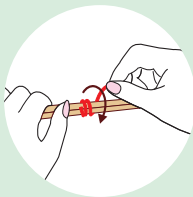

**Bundle easy and tight**

Simply wind the coil around needles to hold them together neatly without slipping.

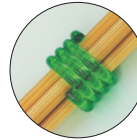
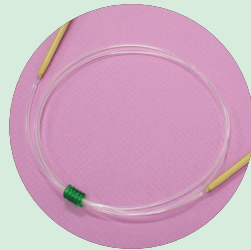

**3122**  
**Coil Knitting Needle Holders (Large)**

3 pcs./pack	3 packs/box
Package Size	5 x 2.6 x 0.5 in

Non-slip holder winds around knitting needles.  
 Needle size:  
 Single Pointed: 10-15  
 Double Pointed: 7-10 1/2

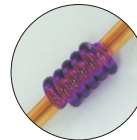

**3123**  
**Coil Knitting Needle Holders (Small)**

5 pcs./pack	3 packs/box
Package Size	5 x 2.6 x 0.3 in

Non-slip holder winds around knitting needles.  
 Needle size:  
 Single Pointed: 2-9  
 Double Pointed: 0-6

**3120**  
**Knitting Needle Tube Case <Designer Case> Purple**

1 pc./pack	3 packs/box
Package Size	17.5 x 2.75 x 1.5 in

Accommodate knitting needles up to 13 3/4 in long. Knitting accessories can be stored in the bottom case.



# Yarn Ball Winder

Smoothly wind balls of yarn with gentle effort

3205	
Yarn Ball Winder	
1 set/pack	1 pack/box
Package Size	6.77 x 6.3 x 5.59 in



Winding capacity: approx. 4.5 oz  
(for light knitting wool)

## Wind a substantial amount of yarn

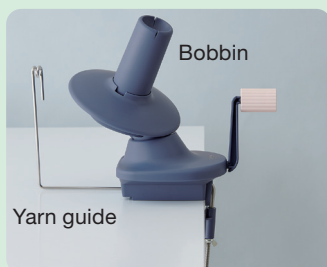

The distance between the bobbin and the yarn guide has been designed to allow ample space for the winding of light knitting wool and ordinary skein (approx. 3.5 oz).

## Winds yarn efficiently

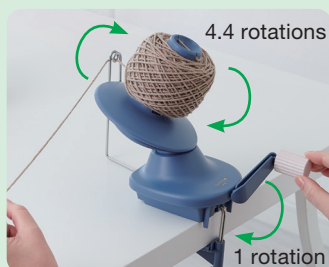

The bobbin turns 4.4 times for each rotation of the handle. This achieves efficient winding of balls of yarn with little movement.

## Handle can be turned with gentle effort



The long handle makes it easy to turn with gentle effort. The handle is oval-shaped for easy gripping. The clamp is equipped with thick rubber to hold the device firmly to the desk for stable winding.



Perfectly wound yarn!

# Black Gold Needles

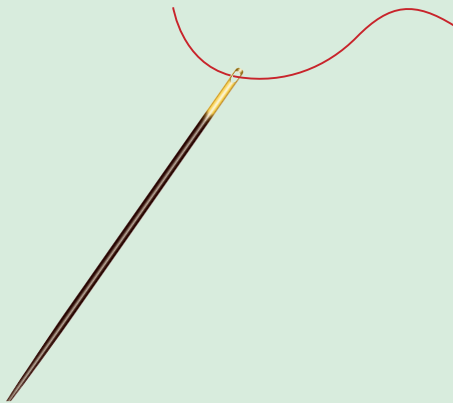

## Needle Surface : Smooth and rust-resistant

### Polished along the needle shaft

Significantly less friction when compared to standard needles. (Clover comparison).

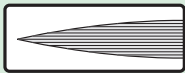

The surface is polished lengthwise.

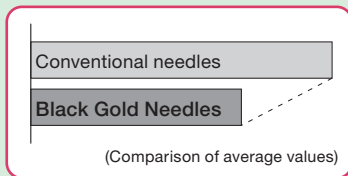

### Special black plating

The special black plating provides outstanding rust resistance compared to conventional nickel plating. (Clover comparison).

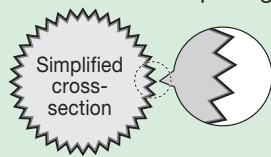

## Needle Tip : Sharp and strong needle tip

Clover's unique polishing process. To strengthen the tip, the first 0.5 mm are polished to a cone shape.



## Needle Eye :

### Shaped for easy threading

Clover's original oval shape adds strength to the eye while lengthening it for easy threading.

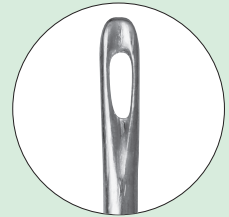

### Gentle on threads

The needle eye is plated with pure gold. The characteristic softness of gold prevents the thread from fraying and breaking.

### Designed to pass smoothly through fabric

Grooved for smooth stitching through fabric.

## Needle Shaft : Bend and break-resistant

The needle shaft uses high-quality steel. Our quenching and tempering processes maximise the strength and elasticity characteristics for the optimum balance.

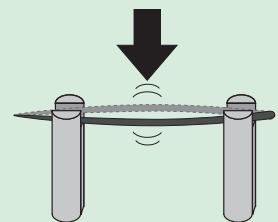



# Black Gold Needles

## Quilting Between



**4960**  
Black Gold Needles  
Quilting Between (No. 9)

0 51221 40336 1

**4961**  
Black Gold Needles  
Quilting Between (No. 10)

0 51221 40337 8

**4962**  
Black Gold Needles  
Quilting Between (No. 12)

0 51221 40338 5

**4963**  
Black Gold Needles  
Quilting Between  
(No. 9/No. 10/No. 12)

0 51221 40339 2

6 needles/pack	3 packs/box
Package Size	6 x 1.9 x 0.1 in

No. 9	0.53 x 27.0 mm
No. 10	0.46 x 25.4 mm
No. 12	0.53 x 24.4 mm

## Quilting



**4980**  
Black Gold Needles  
Quilting (No. 9)

0 51221 40344 6

**4981**  
Black Gold Needles  
Quilting (No. 10)

0 51221 40345 3

**4982**  
Black Gold Needles  
Quilting (No. 12)

0 51221 40346 0

**4983**  
Black Gold Needles  
Quilting (No. 9/No. 10/No. 12)

0 51221 40347 7

6 needles/pack	3 packs/box
Package Size	6 x 1.9 x 0.1 in

No. 9	0.56 x 27.3 mm
No. 10	0.56 x 25.8 mm
No. 12	0.51 x 22.7 mm

## Appliqué/Sharps



**4970**  
Black Gold Needles  
Appliqué/Sharps (No. 9)

0 51221 40340 8

**4971**  
Black Gold Needles  
Appliqué/Sharps (No. 10)

0 51221 40341 5

**4972**  
Black Gold Needles  
Appliqué/Sharps (No. 12)

0 51221 40342 2

**4973**  
Black Gold Needles  
Appliqué/Sharps  
(No. 9/No. 10/No. 12)

0 51221 40343 9

6 needles/pack	3 packs/box
Package Size	6 x 1.9 x 0.1 in

No. 9	0.53 x 34.9 mm
No. 10	0.46 x 33.3 mm
No. 12	0.46 x 28.8 mm

# Sewing, Quilting & Embroidery Needles

## Superior Quality Clover Needles



- The needles will glide through fabric smoothly.
- The needle has Gold-Eye plating with a unique elliptical design for easy threading.
- The hardness of steel was obtained through high temperature treatment and tempering, making our needle hard to break or bend.
- Nickel plated for smooth sewing.
- Sharp needle point.

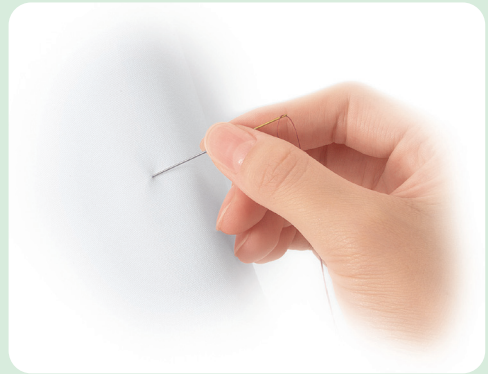

**468/09**  
Quilting Needles  
(No. 9)

0 51221 40105 3

**468/10**  
Quilting Needles  
(No. 10)

0 51221 40103 9

**468/12**  
Quilting Needles  
(No. 12)

0 51221 40101 5

15 needles/pack	12 packs/box
Package Size	5.1 x 2 x 0.1 in



**496/09**  
Gold Eye Quilting Needles  
Between (No. 9)

0 51221 40307 1

**496/10**  
Gold Eye Quilting Needles  
Between (No. 10)

0 51221 40308 8

**496/12**  
Gold Eye Quilting Needles  
Between (No. 12)

0 51221 40309 5

15 needles/pack	12 packs/box
Package Size	5.3 x 2 x 0.1 in

No. 9	0.56 x 27.3 mm
No. 10	0.56 x 25.8 mm
No. 12	0.51 x 22.7 mm

No. 9	0.53 x 27.0 mm
No. 10	0.46 x 25.4 mm
No. 12	0.53 x 24.4 mm



**497/09**  
Gold Eye Appliqué Needles  
(No. 9)

0 51221 40321 7

**497/10**  
Gold Eye Appliqué Needles  
(No. 10)

0 51221 40322 4

**497/12**  
Gold Eye Appliqué Needles  
(No. 12)

0 51221 40323 1

15 needles/pack	12 packs/box
Package Size	5.1 x 2 x 0.1 in

No. 9	0.53 x 34.9 mm
No. 10	0.46 x 33.3 mm
No. 12	0.46 x 28.8 mm



**2006**  
Self Threading Needles  
(Assorted)

0 51221 40707 9

5 needles/pack	12 packs/box
Package Size	5.1 x 2 x 0.1 in

The needles have a built-in threader. Place thread in U-shaped groove and pull down to thread.

0.89 x 42.5 mm
0.76 x 38.0 mm
0.71 x 36.5 mm
0.64 x 42.5 mm
0.64 x 34.9 mm



# Sewing, Quilting & Embroidery Needles



**234/18**  
Gold Eye Chenille Needles  
(No. 18)



**234/20**  
Gold Eye Chenille Needles  
(No. 20)



**234/22**  
Gold Eye Chenille Needles  
(No. 22)



**234/24**  
Gold Eye Chenille Needles  
(No. 24)



6 needles/pack	12 packs/box
Package Size	5.3 x 2 x 0.1 in



**235**  
Gold Eye Embroidery Needles  
(No. 3 - 9)



16 needles/pack	12 packs/box
Package Size	5.3 x 2 x 0.1 in

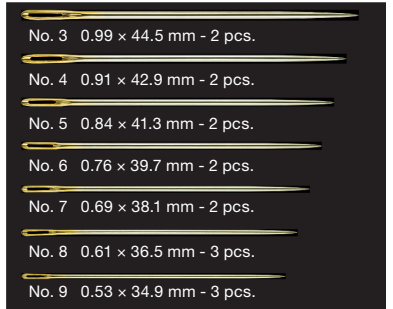

**238**  
Gold Eye Tapestry Needles  
(No. 18, 20, 22)



**238/24**  
Gold Eye Tapestry Needles  
(No. 24)



6 needles/pack	12 packs/box
Package Size	5.3 x 2 x 0.1 in



**2012**  
Huck Embroidery Needles



3 needles/pack	12 packs/box
Package Size	5.8 x 2 x 0.1 in

The tip is rounded and curved so cloth can be easily scooped.

238/24



# Sewing, Quilting & Embroidery Needles



**2007**  
**Sashiko Needles**

8 needles/pack	12 packs/box
Package Size	5.1 x 2 x 0.1 in

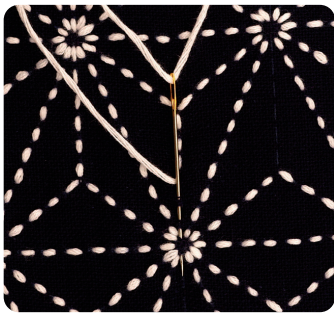

**2009**  
**Sashiko Needles (Long Type)**

3 needles/pack	12 packs/box
Package Size	5.8 x 2 x 0.1 in

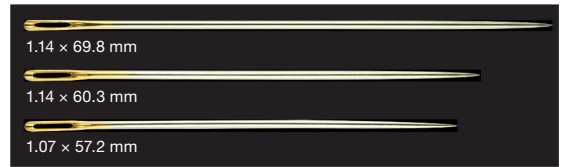
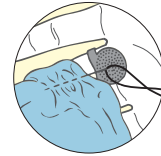

**237/10**  
**Gold Eye Sharps Needles (No. 10)**

20 needles/pack	12 packs/box
Package Size	5.3 x 2 x 0.1 in



**236**  
**Gold Eye Milliners Needles (No. 3, 5, 7, 9)**

16 needles/pack	12 packs/box
Package Size	5.3 x 2 x 0.1 in

Long needles with round eyes used for: Bonnet and hat making, pleating, ribbon embroidery and embellishing decorations.

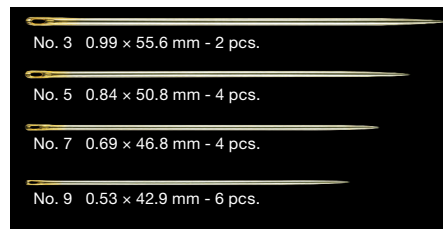

**233**  
**Beading Needles (No. 10, 13)**

4 needles/pack	12 packs/box
Package Size	5.3 x 2 x 0.1 in

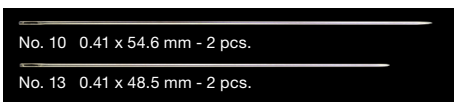

# Sewing, Quilting & Embroidery Needles

Easily repair snags in knitted and woven garments!



2512	
Snag Repair Needles	
2 needles/pack	3 packs/box
Package Size	6.68 x 2 x 0.06 in

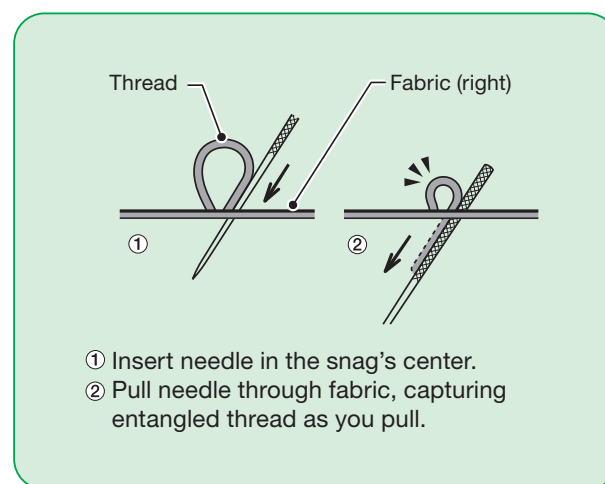
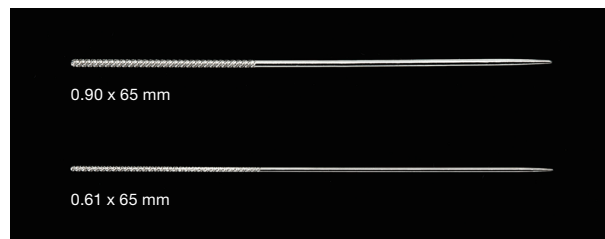
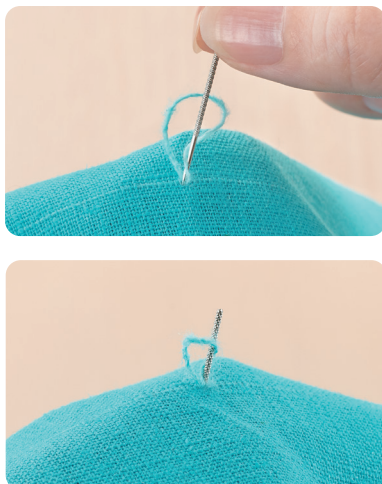

## Pins

### Wonder Pins



3210	
Wonder Pins (20 pcs.)	
20 pcs./pack	3 packs/box
Package Size	4.72 x 2.87 x 0.83 in



### Quick and easy quilt basting

The curved pin makes scooping and holding the fabric easy.

- Scoop 3 layers (top, batting and backing) of fabric keeping them spread out flat.
- Tip manufactured to ensure ease of pinning through fabric.

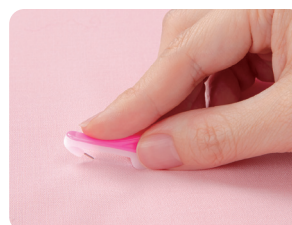
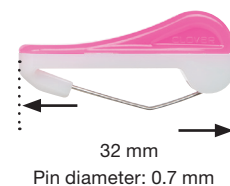

Simply push the pin down. Easily open and close with one hand.

Speedy basting and reduced hand fatigue.



Can be used in places where Clips cannot reach.

With closed pins, no worry about pricking yourself.

### How to use

1. Scoop up the fabric.
2. Push down the closure, keeping the pin tip upwards and the base of pin touching fabric surface.
3. The pin is secured when it enters the closure.

## Marbled Glass Head Pins

Heat resistant glass head suited for ironing.

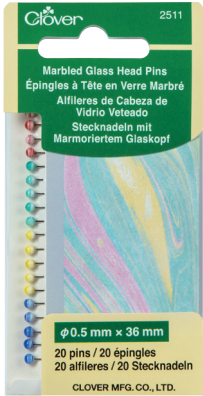

<b>2511</b>	
<b>Marbled Glass Head Pins</b>	
	
1 set/pack	3 packs/box
Package Size	4.53 x 2.48 x 0.16 in





0.50 x 36 mm  
20 pins

- 0.5 mm thin marking pins.
- Holes are hardly visible and the pins will smoothly pass through fabrics.
- The pins have a fine pointed tip and is made of tough steel.

## Flower Head Pins

Flower Head Pins can hold multiple layers of fabric.  
The flat head is convenient for machine stitching.  
Head is not heat-resistant. Do not apply iron directly. 3 different sizes.



<b>2505</b>	
<b>Flower Head Pins</b>	
<b>0.55 mm</b>	
	

**2505**



0.55 x 50 mm

The pins will hold regular fabric of cotton, linen and wool.

<b>2510</b>	
<b>Flower Head Pins</b>	
<b>0.45 mm</b>	
	

**2510**



0.45 x 50 mm

Superfine-pointed, 0.45 mm marking pins will pass through fabric smoothly. The pins will gently hold thin fabrics such as silk, silk crepe, satin and lining fabric.



<b>2506</b>	
<b>Flower Head Pins Boxed</b>	
	
100 pins/case	3 cases/box
Package Size	4.1 x 2.9 x 0.9 in

**2506**



0.70 x 54 mm

## Heart-Shaped Pins



<b>9604</b>	
<b>Heart-Shaped Pins</b>	
	
1 set/pack	3 packs/box
Package Size	4.53 x 2.36 x 0.16 in

**Easy-grasp large head and sharp finish!**

The heart-shaped head featured on these pins make them easy to grab, the sharp finish make them easy to use. Their flat head is convenient for machine stitching and ironing.

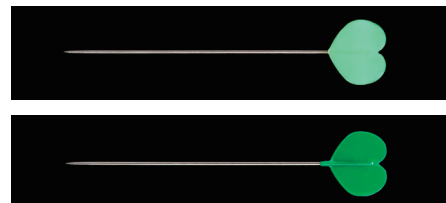

0.55 x 50 mm 20 pins

# Pins

## Fork Pins

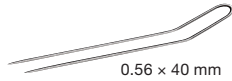

**2401**  
Fork Pins (70 pcs.)



70 pins/case    3 cases/box  
Package Size 5.12 x 2.91 x 0.63 in

**240**  
Fork Pins (35 pcs.)



35 pins/case    3 cases/box  
Package Size 5.12 x 2.95 x 0.67 in

The double pins can pierce and firmly hold slippery lining materials in place. The tip is bent for easy pinning.



**232**  
Patchwork Pins



100 pins/case    3 cases/box  
Package Size 4.5 x 2.4 x 0.6 in

The needle head is small and the tip is sharp. The pins have very sharp points.

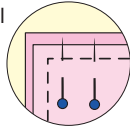

**2501**  
Silk Pins Boxed



100 pins/case    3 cases/box  
Package Size 4.5 x 2.88 x 0.63 in

Suitable for thin fabrics.



**2508**  
Quilting Pins



100 pins/case    3 cases/box  
Package Size 4.5 x 2.4 x 0.6 in

Perfectly suited for quilting, as the pins feature a sharp tip and strong shaft.



**2507**  
Patchwork Pins (Fine)



100 pins/case    3 cases/box  
Package Size 4.5 x 2.4 x 0.6 in

Extra-fine pins, which smoothly pass through fabric. Useful for precise pinning in delicate piecework and appliqué.



**231**  
Appliqué Pins



150 pins/case    3 cases/box  
Package Size 4.5 x 2.3 x 0.5 in

Short pins (2 cm) are perfect for small appliqué work. It will not stick out since it is short.



**2509**  
Quilting Pins (Fine)



100 pins/case    3 cases/box  
Package Size 4.63 x 2.4 x 0.63 in

Pins smoothly pass through fabric, as the pin tips are thin and sharp.



**NP100H**  
Thumb Tacks with Remover



60 pins/case    10 cases/box  
Package Size 3.4 x 1.9 x 0.8 in



# Wonder Clips

All you have to do is clip it on and off

## Mini Wonder Clips

- Great alternative to pins, especially when working with vinyls, piles, and heavy weight fabrics.
- The small size works well with miniature patchwork, doll clothes, and all work that requires holding pieces together in tight sections.
- It is helpful when holding a curved line or for a short distance.
- Easy to see on your work and easy to find when dropped to the floor.

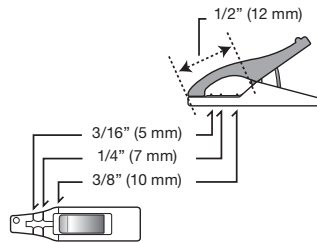

**3188**  
**Mini Wonder Clips**  
**(20 pcs.)**

20 pcs./pack	3 packs/box
Package Size	7.5 x 3.15 x 0.59 in

**3189**  
**Mini Wonder Clips**  
**(Assortment/50 pcs.)**

50 pcs./pack	3 packs/box
Package Size	5.9 x 3 x 1.3 in

### Clips to temporarily hold fabric together for sewing <mini>

Narrow tips for precision clipping

Maximum  
5/16 in

Small but  
opens wide!

Narrow tip with 4  
projections to clip tightly!

A guide scale which can estimate seam allowances  
in units of 3/16, 1/4 and 3/8 in

- Precision clipping.
- Small and light.
- Works well with sergers.
- As a marking for pieces of fabric.
- Comes with a 3/16 in, 1/4 in, & 3/8 in scale.

The back of the clip is flat, keeping the fabric down, for easy feeding into the presser foot

When viewing  
from the back

Clips can be aligned  
with notch marks

3/16 in  
1/4 in  
3/8 in

When viewing  
from the front

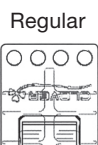
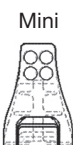

Though small, the Mini Wonder Clips have the same number of projections and clipping power as the regular Wonder Clips.



# Wonder Clips

All you have to do is clip it on and off

## Wonder Clips

- Great alternative to pins, especially when working with vinyls, piles, and heavy weight fabrics.
- Holds layered sections of sewing projects such as, handle connectors to handbags, piping, etc. without distortion.
- Holds quilt binding while sewing.
- Easy to see on your work and easy to find when dropped to the floor.
- Works well with sergers.

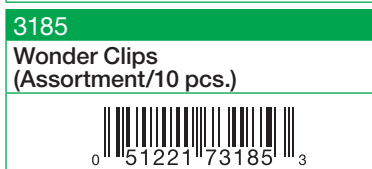
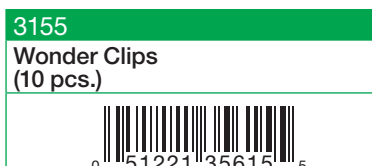

10 pcs./pack	3 packs/box
Package Size	7.5 x 3.15 x 0.6 in



3155/3156/3159



3180

Maximum  
1/3 in

Seam allowance can be estimated in units of 3/16 in, 1/4 in, 3/8 in.

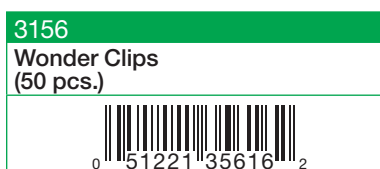

50 pcs./pack	3 packs/box
Package Size	6 x 3 x 0.5 in



3183/3185

Dressmaking requires many pins.

# Wonder Clips

All you have to do is clip it on and off



**3159**  
**Wonder Clips (100 pcs.)**

100 pcs./pack	3 packs/box
Package Size	8.46 x 4.72 x 2 in

Perfect for dressmaking which requires many pins to hold fabrics together.



## Jumbo Wonder Clips

- Clip opens wide to hold layers of fabrics.
- Each clip can hold a length of up to 3 cm.
- These clips are convenient for holding wide seam allowances, pouch openings and handles.
- These can be used for patchwork, quilt, knitting and other various handicrafts.
- Flat back for keeping fabrics down, making it easy to use on sewing machines.



**3157**  
**Jumbo Wonder Clips (24 pcs.)**

24 pcs./pack	3 packs/box
Package Size	8.46 x 4.72 x 2 in



**Wide Opening**

**Maximum 3/4 in**

**Guide Scale**

**Flat Back**

The clips are useful in holding laminated fabrics, synthetic leathers and other fabrics on which you do not wish to leave holes.

The wide opening of the clips are also suitable for holding thick fabrics and zippers.

## Wonder Clips <Variety Pack>



**3190**  
**Wonder Clips <Variety Pack> (26 pcs.)**

26 pcs./pack	3 packs/box
Package Size	7.87 x 3.94 x 1.58 in

All in one convenient package, each unique clips holds your work in place.



**Mini**  
10 pcs

**Classic**  
10 pcs

**Jumbo**  
6 pcs

# Thimbles

## Leather Thimbles



**6028**  
Natural Fit Leather Thimble (Small)



**6029**  
Natural Fit Leather Thimble (Medium)



**6030**  
Natural Fit Leather Thimble (Large)



1 pc./pack	3 packs/box
Package Size	6 x 2.4 x 0.8 in



**6038**  
Natural Fit Leather Thimble (Small) Limited Edition



**6039**  
Natural Fit Leather Thimble (Medium) Limited Edition



**6040**  
Natural Fit Leather Thimble (Large) Limited Edition



1 pc./pack	3 packs/box
Package Size	6 x 2.4 x 0.8 in



### Feature 1 Seamless from top to side!

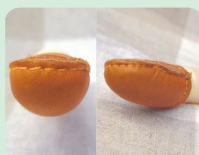

This thimble is made with three-dimensional stitching without seams or stitches in the area where the needle touches, allowing the needle to be pushed from the most convenient spot. Its side is made of full double leather to provide safety.

### Feature 2 Fits the curve of your finger tip naturally!



The unique shape creates a smooth curve from the edge of the fingertip to the middle of the finger.

It fits the curve of your finger tip naturally.



**6014**  
Coin Thimble (Medium)



1 pc./pack	3 packs/box
Package Size	4.9 x 2 0.4 in

Soft leather thimble with coin metal dimpled disk.

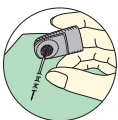

**612**  
Leather Thimble



2 pc./pack	3 packs/box
Package Size	4.9 x 2 x 0.5 in

Made of soft leather. The leather thimbles can be adjusted to fit any finger size.

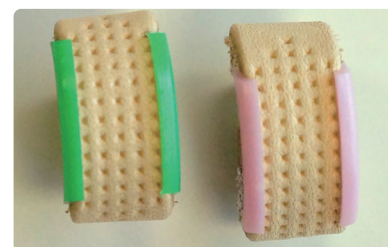

**616**  
Double Sided Thimble



1 pc./pack	3 packs/box
Package Size	4.92 x 2 x 0.6 in

Made of soft leather. This thimble has double sided metal "dimpled" tip.



# Thimbles

## Protect and Grip Thimbles



**6025**  
**Protect and Grip Thimble (Small)**

1 pc./pack	3 packs/box
Package Size	6 x 2.5 x 0.8 in



**6026**  
**Protect and Grip Thimble (Medium)**

1 pc./pack	3 packs/box
Package Size	6 x 2.5 x 0.8 in



**6027**  
**Protect and Grip Thimble (Large)**

1 pc./pack	3 packs/box
Package Size	6 x 2.5 x 0.8 in

**Finger friendly soft rubber** Fits gently on your finger without a tight feeling

**Excellent reathability** with its unique corrugated shape

**Dimpled and Ridged**

**Metal top that can be pushed firmly** without danger

**50 to 80% lighter** than a metal thimble (compared to our conventional product)

Because only a small area touches your finger, this thimble does not make your finger sweaty.

## Flexible Rubber Thimbles

*Tight grip to easily pull out the needle.*



**6031**  
**Flexible Rubber Thimbles (Medium)**

2 pcs./pack	3 packs/box
Package Size	5.91 x 2.56 x 0.79 in



**6032**  
**Flexible Rubber Thimbles (Large)**

2 pcs./pack	3 packs/box
Package Size	5.91 x 2.56 x 0.79 in

- Index finger thimble for easily pulling needle through fabric.
- Flexible for a perfect fit.
- Cooling vents for breathability.

# Thimbles



**610**  
**Adjustable Ring Thimble**

1 pc./pack	3 packs/box
Package Size 4.1 x 2.6 x 0.6 in	



**611**  
**Adjustable Ring Thimble with Plate**

1 pc./pack	3 packs/box
Package Size 4.1 x 2.6 x 0.6 in	



The metal thimble can be used for thick needles and can be adjusted to any finger size.

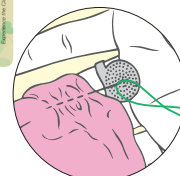

Designed for long-running stitches using a long needle or Sashiko.  
Adjustable to fit any finger.

**6017**  
**Open Sided Thimble (Small)**

1 pc./pack	3 packs/box
Package Size 5.6 x 2.5 x 0.8 in	

**6018**  
**Open Sided Thimble (Medium)**

1 pc./pack	3 packs/box
Package Size 5.8 x 2.4 x 0.8 in	



6017



6018

Adjustable Open Sided Thimble that fits your finger comfortably.  
Designed with an open top to keep your finger from perspiring.  
Dimpled for easy use on needles.  
Suited for people with long fingernails.

# Sewing Notions

Used to cut threads by placing the longer tip under the thread and pushing forward.

The seam ripper comes with a small ball to protect it from damaging the fabric.



**482/W**  
**Seam Ripper**

1 pc./pack	3 packs/box
Package Size 7.25 x 1.75 x 0.5 in	

Used to cut seams, basting threads or threads under buttons.

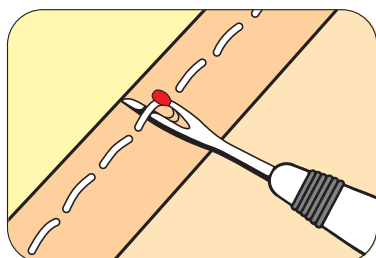

**463**  
**Seam Ripper**

1 pc./pack	3 packs/box
Package Size 7.3 x 2.9 x 0.3 in	

Perfect for ripping out seams, cutting threads and buttonholes.

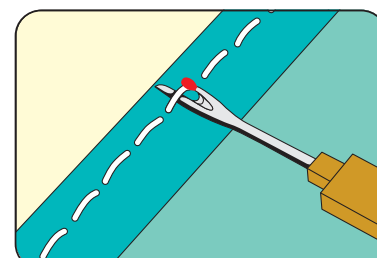



480/W	
Tracing Wheel (Serrated Edges)	
1 pc./pack	3 packs/box
Package Size	7.5 x 1.4 x 0.5 in

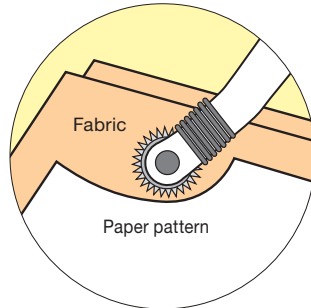

The tracing wheel is used for marking directly onto fabrics. Suitable for marking on thin fabrics.

Trace and mark the holes by rolling the wheel forward along the paper pattern.



481/W	
Tracing Wheel (Blunt Edges)	
1 pc./pack	3 packs/box
Package Size	7.5 x 1.8 x 0.5 in

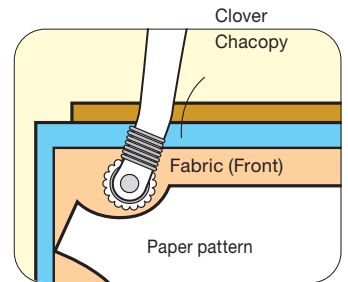

This wheel is used when transferring the pattern to fabrics using Tracing Paper "Clover Chacopy".

The blunt edges will mark the line without tearing the pattern or Chacopy carbon paper.



487/W	
Double Tracing Wheel	
1 pc./pack	3 packs/box
Package Size	7.6 x 1.75 x 0.5 in

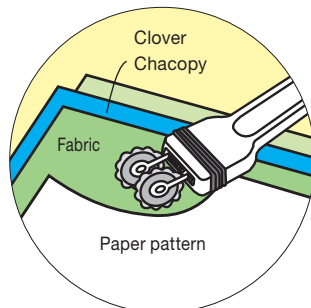

The Double Tracing Wheel can draw two lines at the same time and the space between each wheel can be changed in units of 5 mm.

Seam line and cutting line can be marked at the same time.

The space between the two wheels can be adjusted in units of 5 mm between 10-30 mm.



484/W	
Buttonhole Cutter	
1 pc./pack	3 packs/box
Package Size	7.5 x 1.75 x 0.5 in

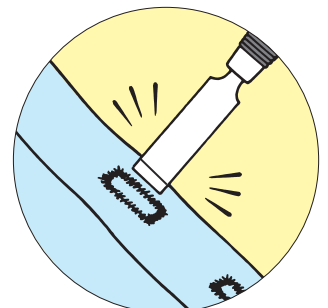

This cutter makes the job of opening buttonholes or small cuts on fabrics easy.

After stitching a buttonhole, use this cutter to open it by placing and pressing the blade on the beads of the buttonhole vertically.

This cutter is also useful for making small cuts and cutting through curves. (12 mm wide)

# Sewing Notions

*The Straight Tailor's Awl and the Tapered Tailor's Awl are convenient for detailed work.*

These awls are used for detailed work such as shaping the edges, feeding the cloth into the sewing machine and untying threads. With a sharp edge like an artillery shell, the awl is suitable for marking and opening holes especially for thick fabrics and leather.

<b>485/W</b>	
<b>Straight Tailor's Awl</b>	
1 pc./pack	3 packs/box
Package Size	7.5 x 1.8 x 0.5 in

Designed for piercing small holes or craft works for doll making.

<b>486/W</b>	
<b>Tapered Tailor's Awl</b>	
1 pc./pack	3 packs/box
Package Size	7.5 x 1.8 x 0.5 in

Useful in punching holes in leather and fabrics, pulling out corners, and widening out spaces.

<b>4880</b>	
<b>Curved Tailor's Awl</b>	
1 pc./pack	3 packs/box
Package Size	7.5 x 1.77 x 0.53 in

With its curved tip, this awl is perfect for such tasks as producing curves, feeding cloth, or undoing seams. In addition, the tip has a smooth finish, which makes injury to the cloth or your fingers difficult.

<b>876</b>	
<b>Ball Point Awl</b>	
1 pc./pack	3 packs/box
Package Size	7.5 x 1.8 x 0.4 in

The Ball Point Awl is used for making a hole by carefully stretching the fabric without thread breakage.

# Sewing & Patchwork Accessories

## Sweet 'n Sharp Macaron

*Cute magnetic needle holder & Needle sharpener.*

- Catch needles on magnetic surface.
- Polish needles with cream filled cushion.
- Needles sharpened regularly penetrate smoothly the fabric.



<b>4130</b>		<b>4131</b>	
<b>Sweet 'n Sharp Macaron (Raspberry)</b>		<b>Sweet 'n Sharp Macaron (Pistachio)</b>	
1 pc./pack	3 packs/box	1 pc./pack	3 packs/box
Package Size	4.72 x 2.36 x 0.91 in	Package Size	4.72 x 2.36 x 0.91 in

**How to polish needles**

1. Insert the needle slowly into the central filling cushion part.
2. Hold the upper and lower sides of the macaron.
3. While checking the polishing condition, insert and pull out the needle several times.

# Sewing & Patchwork Accessories



**4000**  
Threader

0 51221 52227 7

2 pc./pack	36 packs/box
Package Size	4.1 x 1.9 x 0.1 in



**462/NV**  
Double Needle Threader

0 51221 52109 6

1 pc./pack	3 packs/box
Package Size	6 x 1.63 x 0.38 in

Thread both large-sized and small-sized needles.

How to use:

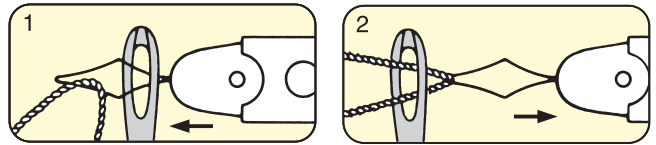

**478**  
Threader with Cutter "PETIT CUT"

0 51221 52115 7

2 pcs./pack	3 packs/box
Package Size	4.3 x 2.6 x 0.3 in

Threader and cutter in one.

How to use:

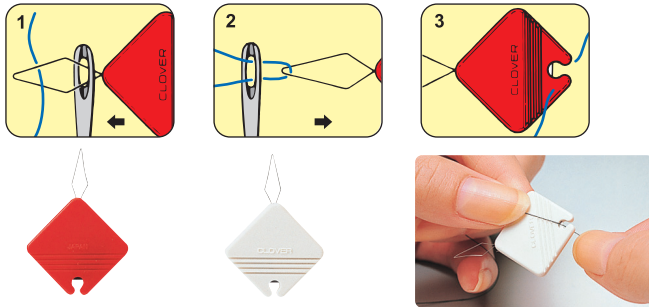

**466**  
Quilt Needle Threader

0 51221 52116 4

1 pc./pack	3 packs/box
Package Size	4.1 x 2.5 x 0.4 in

Antique gold Quilt Needle Threader used for threading fine needles.

How to use:

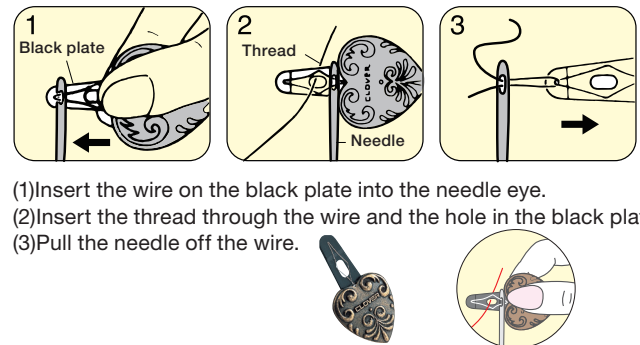

## Eye-catching design with new functions.

Threader specially designed for embroidery threads (embroidery needles).



**8611**  
Embroidery Threader

0 51221 55811 5

1 pc./pack	3 packs/box
Package Size	5.88 x 2.13 x 0.38 in

Comes with a cap



Embroidery Threader has a "Flat tip" for easy and smooth threading even with thick threads.

Thread even thick threads smoothly

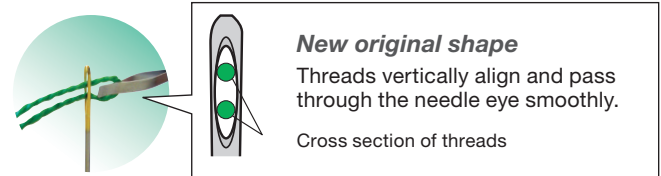

### New original shape

Threads vertically align and pass through the needle eye smoothly.

Cross section of threads

\*Please use the designated number and types of threads for each embroidery needle.



# Sewing & Patchwork Accessories

Thread both large-sized and small-sized needles easily and flawlessly.

You can easily thread needles of any size by inserting them into the same place and pressing a button. Most of Clover Needles (0.51-0.89 mm) for sewing and patchwork can be threaded.

Choose Clover Needles for smooth threading!



**4071**  
Desk Needle Threader  
(Purple)

1 pc./pack	3 packs/box
Package Size	5.8 x 4.1 x 0.9 in

**4072**  
Desk Needle Threader  
(Green)

1 pc./pack	3 packs/box
Package Size	5.8 x 4.1 x 0.9 in

**4073**  
Desk Needle Threader  
(Pink)

1 pc./pack	3 packs/box
Package Size	5.8 x 4.1 x 0.9 in

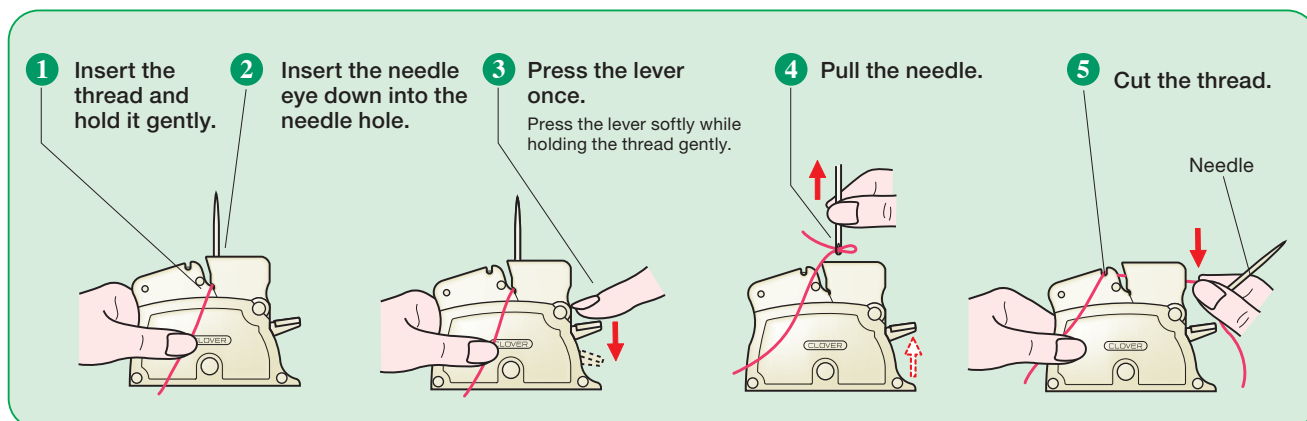

Caution: If the thread does not go through, place the needle down and repeat the procedures **1** to **4**.

<Cautions for use>

- Make sure the thread thickness is applicable to the size of the needle.
- When the thread is pushed through the eye of the needle with too much force, it may be damaged. In this case, pull thread through the eye and cut off the damaged part.
- To store this product, remove needle.

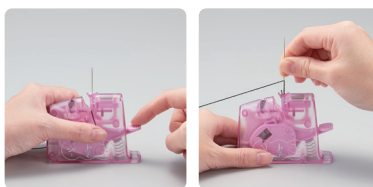

**4074**  
Quick Desk Needle Threader

1 pc./pack	3 packs/box
Package Size	6 x 3.35 x 1.14 in

Perfectly threads your needle. Most of Clover Needles (0.46-0.89 mm) for sewing and patchwork can be quickly threaded at a press of a button.

# Sewing & Patchwork Accessories

## Dome Threaded Needle Case

Store threaded needles by winding them onto the reel!



**625**  
**Dome Threaded Needle Case**

1 pc./pack	3 packs/box
Package Size	6.5 x 3.9 x 1.3 in

Store 10 threaded needles neatly!



### How to Use:

(1) Insert the threaded needle into the groove.

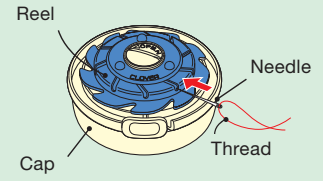

(2) Rotate dome to wind the thread.

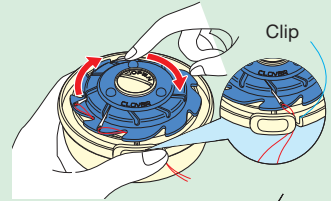

(3) To remove the needle, hold the dome and pull the needle slowly.

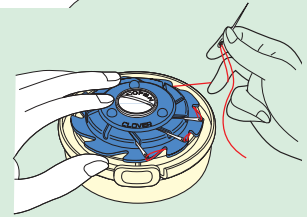

## Magnet Pin Caddy

Drop needles on the Magnet Pin Caddy and it will catch and store them in the same direction with its magnetic force.



**4105**  
**Magnet Pin Caddy (Bordeaux)**

1 pc./pack	3 packs/box
Package Size	7.28 x 4.72 x 1.57 in

Center groove makes picking up pins from caddy easy.

Includes cover for safe and easy storage that also allows for stacking multiple caddy, and comes with fine and smooth Clover Silk Pins (10 pins) for trial.



**9575**  
**Pin 'n Stow**  
 with NANCY ZIEMAN®

1 pc./pack	3 packs/box
Package Size	10.43 x 4.33 x 0.79 in

Magnetic band fits to wrist with a "Slap." Grooved for easy pickup.

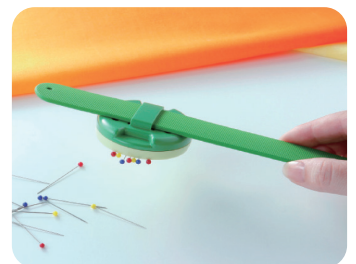

# Sewing & Patchwork Accessories



**4910**  
**Soft Touch Thread Pick**

1 pc./pack	3 packs/box
Package Size	7.5 x 1.5 x 0.5 in

- The perfect tool for hiding or removing stray threads
- Easily slips through the top fabric, leaving no marks or punctures
- Ideal for long-arm quilters and machine embroidery

Steel tip

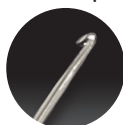

Optimal shape for grabbing thread!

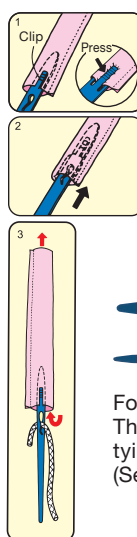
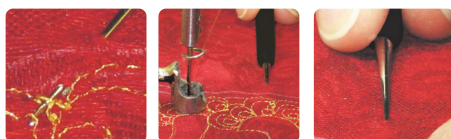

**472**  
**Easy Loop Turner**

2 pcs. (2 sizes)/pack	3 packs/box
Package Size	13 x 1.77 x 0.16 in



For turning loops inside out. The loop can be used to insert cording by tying it to the hole. (See illustration 3.)



**4001**  
**Bodkin (2 Types)**

2 pcs./pack	3 packs/box
Package Size	4.96 x 1.97 x 0.28 in

For threading of ribbon and elastic tape.

Slide to lock.

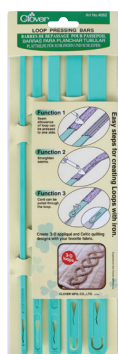
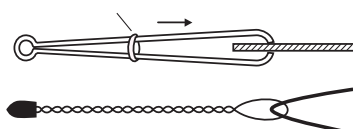

**4052**  
**Loop Pressing Bars**

5 pcs. (5 sizes)/pack	3 packs/box
Package Size	13.4 x 4.5 x 0.3 in

Easily make loops, 3D appliqué and Celtic designs.

Seam allowance can be pressed with iron.

The loop can be used to insert cording by tying it to the hole.

Available widths: 6, 9, 12, 15, 18 mm



**9582**  
**Clip 'n Glide Bodkin**

1 pc./pack	3 packs/box
Package Size	9 x 2.87 x 0.43 in

Clip provides firm hold on elastic end for pulling through casing with ease.

Suitable elastic width: 5/8 in. (15 mm) or wider

Width of casing opening: 3/4 in. (20 mm) or wider

Exceptional flexibility ensures smooth passage along curvy areas.

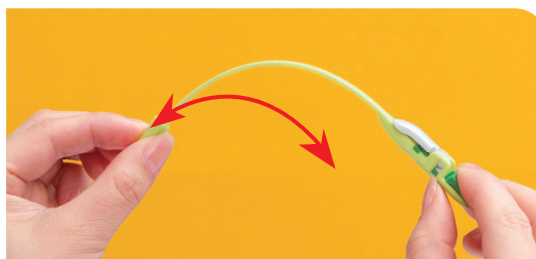
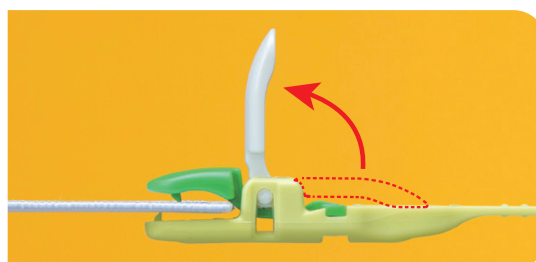

# Sewing & Patchwork Accessories

## "Quick Cut" Thread Cutter

The "Quick Cut" Thread Cutter allows you to quickly and easily separate your quilt chain pieces.



7490	
"Quick Cut" Thread Cutter	

1 pc./pack	3 packs/box
Package Size	5.5 x 2.36 x 1.6 in



You can move the blade 12 positions to get a new blade edge.



Our unique design protects your fingers when you set and cut the thread.

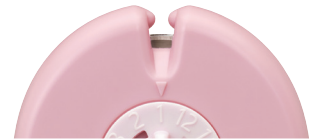

\* It features Clover's 45 mm Rotary Cutter blade which can be replaced.



415	
Thread Clipper "KUROHA"	

1 pc./pack	3 packs/box
Package Size	7.3 x 3 x 0.5 in

High quality precision clipper with excellent sharp cutting edge.

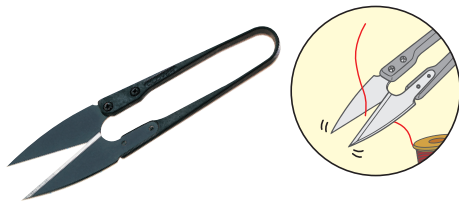

454	
Thread Cutter Pendant (Antique Silver)	

455	
Thread Cutter Pendant (Antique Gold)	

1 pc./pack	3 packs/box
Package Size	4.1 x 2.6 x 0.3 in



The thread cutter pendant has a built-in sharp circular blade to cut threads.

It can be set on top of a thread wheel or used as a pendant.

Available in antique silver & antique gold.



522	
Thread Tweezer	

1 pc./pack	5 packs/box
Package Size	7.25 x 3 x 0.5 in



# Sewing & Patchwork Accessories



**7007**  
**Pattern Cutting Guide**



1 pc./pack	3 packs/box
Package Size 4.72 x 2.87 x 0.83 in	

Makes it easy to cut paper patterns with seam allowance.



Hold the lever and place the cutter so the blade protrudes a little.

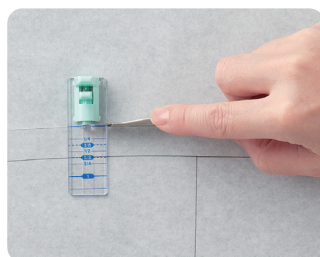

Cut the paper pattern aligning the stitch line with the desired seam allowance on the guideline.



**9507**  
**Seams Right**



1 pc./pack	3 packs/box
Package Size 6.4 x 3.1 x 0.1 in	

Multipurpose measuring tool for sewing, quilting, knitting, crochet and embroidery.



## A sewing ruler with adequate flexibility.

These rulers are perfect for sewing/knitting drafts or drawing seam lines.

Parallel lines can be drawn accurately at several distances.

The rulers are made of a flexible material to help measure curved portions.

You can clearly read scales even on dark-coloured fabrics and easily draw a true bias line with a 45° line.

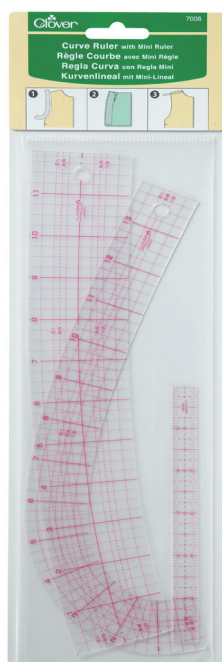
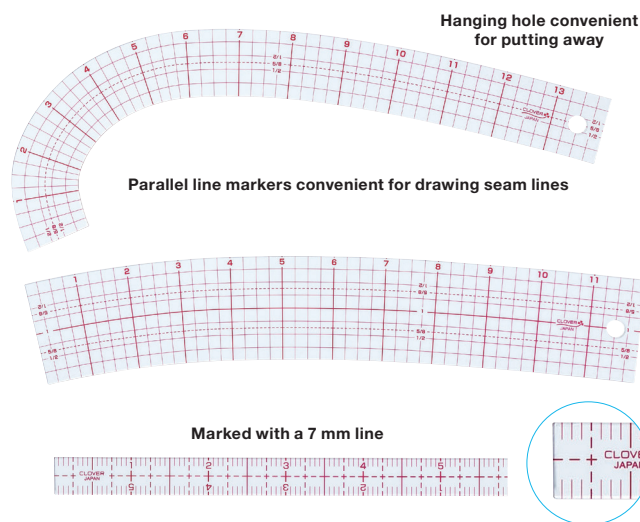

**7006**  
**Curve Ruler with Mini Ruler**



1 set/pack	3 packs/box
Package Size 15.6 x 4.33 x 0.16 in	



Curves perfect for sewing

Deep curve  
For the neckline or armhole

Gentle curves  
For the hem and hip lines



The rulers come with a case.

**The compact, easy-to-use curve ruler with parallel lines is useful for marking seam allowances.**

These rulers are optimal for drawing curved lines when copying sewing patterns, creating drafts, or drawing curved seam lines quickly and neatly.

Parallel lines are marked along the edge of the curve, enabling the drawing of curved seam lines easily. This is a set of two curve rulers and a mini ruler (15 cm).

# Sewing & Patchwork Accessories

*This ruler can simplify three-folding, hemming and cloth wrapping.*

Measure, mark, and press hems and more in one step. Great for deep hems, long hems and to miter corners.

Heat resistant, thin, accurate ruler can be pressed with dry/steam iron, features non-slip surface to hold fabric for precise results.

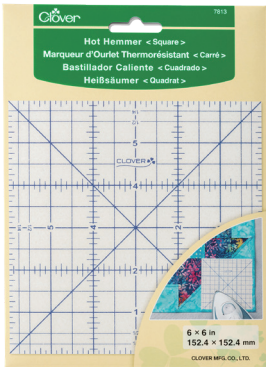

6 x 6 in.

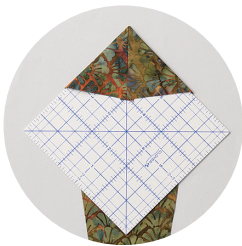

**7813**  
Hot Hemmer <Square>

1 pc./pack	3 packs/box
Package Size	8.66 x 6.3 x 0.12 in

Great for pressing all sizes of dresden wedges, under edges of quilt block appliqué, and geometric appliqué for quilting.

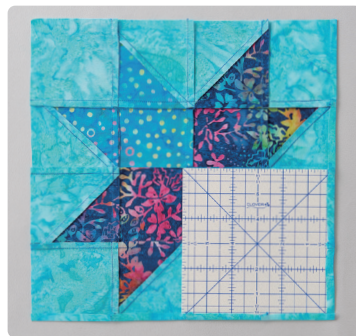

*This ruler is convenient for folding fabric over a long straight line or a curve*



Thickness: 1.0 mm

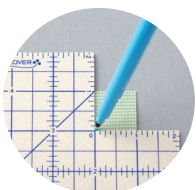

**7806**  
Hot Hemmer

1 pc./pack	3 packs/box
Package Size	9.84 x 5.43 x 0.08 in

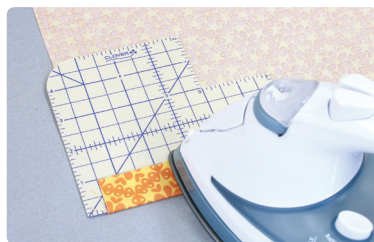

2 1/2 x 10 in.

**7811**  
Hot Ruler

1 pc./pack	3 packs/box
Package Size	12.2 x 3.9 x 0.08 in

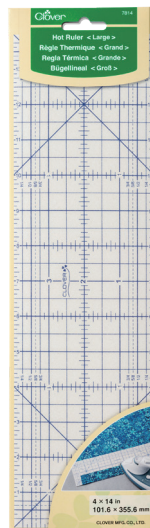

4 x 14 in.

**7814**  
Hot Ruler <Large>

1 pc./pack	3 packs/box
Package Size	14.96 x 4.33 x 0.12 in

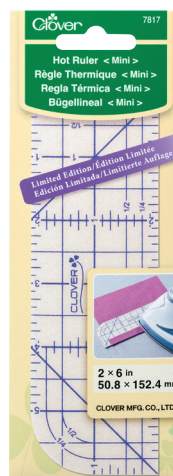

2 x 6 in.

**7817**  
Hot Ruler <Mini>

1 pc./pack	3 packs/box
Package Size	7.5 x 2.76 x 0.12 in



# Sewing & Patchwork Accessories

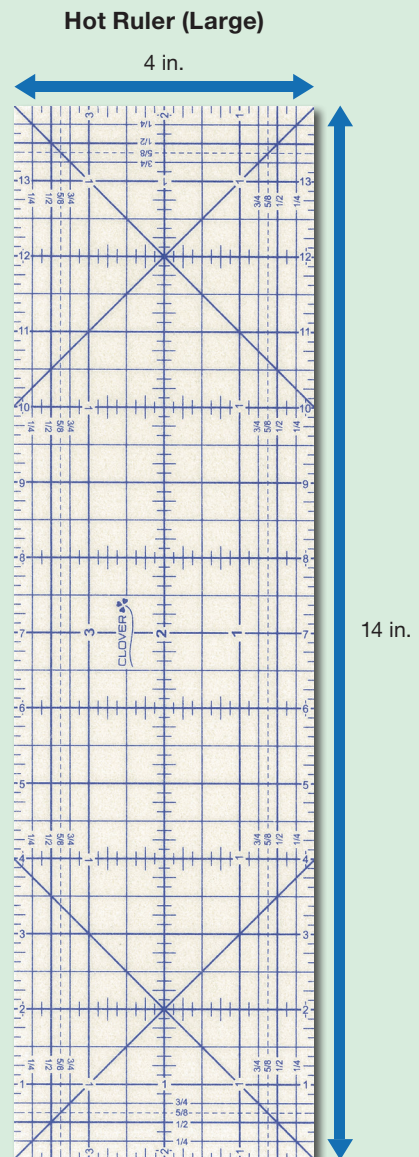
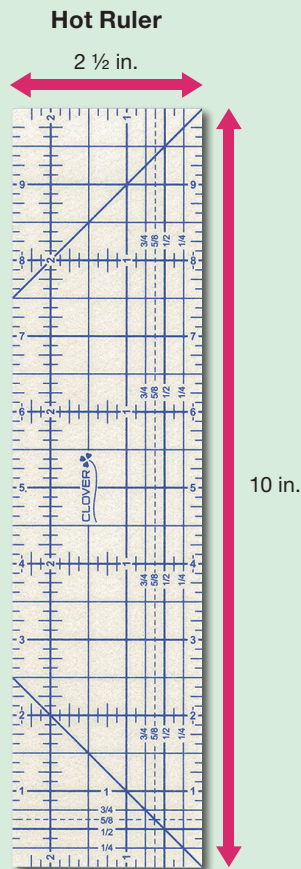
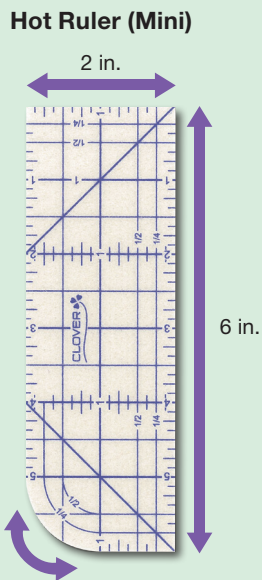
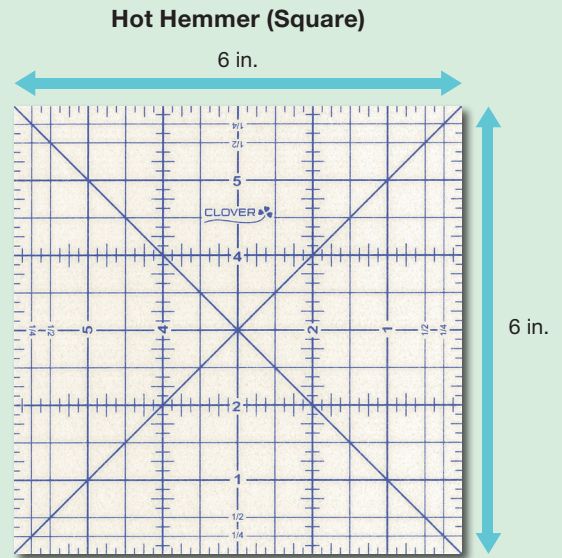
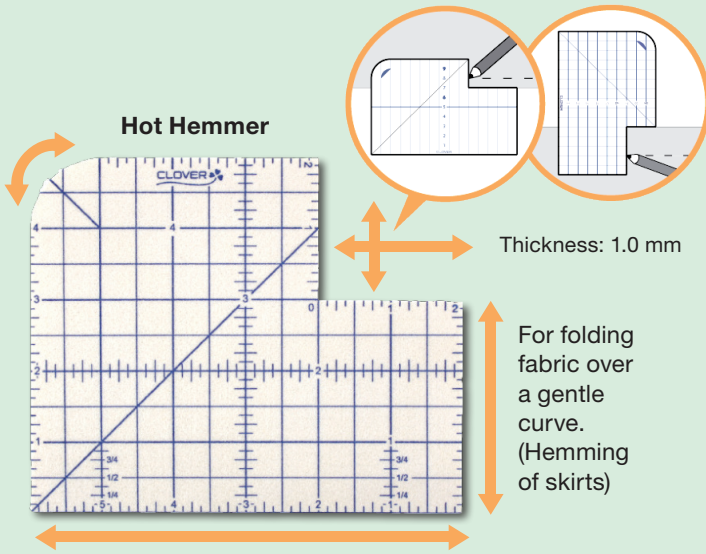

# Sewing & Patchwork Accessories



**4091**  
**Wonder Fuse (18 in. x 3 yd roll)**

1 roll/package	3 packs/box
Package Size	19.7 x 2.44 x 2.44 in

- Lightweight, fusible web.
- Useful for appliqué on apparel, quilts, embroidery, and more.

**4090**  
**Wonder Fuse (9 x 8 in. sheets)**

10 pcs/package	3 packs/box
Package Size	11.81 x 8.78 x 0.1 in

**Wonder Fuse**  
**Papier Thermofusibles Prodiges**  
**Fusibile Prodigiouso**  
**Wundervollies**

Lightweight and  
 Fusible fabric  
 Laminates fabric

Useful for appliqué on apparel, quilts,  
 embroidery, home decor and crafts.

Utilise le papier thermofusibles prodiges pour appliquer des motifs sur des  
 vêtements, des couvertures, des broderies, des décorations intérieures et pièces artisanales.

Useful for appliqué on apparel, quilts, embroidery, home decor and crafts.

Utilise le papier thermofusibles prodigos para aplicar los motivos de papel sobre  
 prendas de vestir, edredones, bordados, decoración casera y artesanales.

Utili para la aplicación en prendas de vestir, edredones,  
 bordados, decoración casera y artesanales.

Geeignet für Applikationen auf Kleidung, Stepparbeiten,  
 Stickereien, Wohn Dekor und Handwerksarbeiten.

Use with iron  
 Utilise un fer à repasser  
 Use with iron  
 Utilise un fer à repasser  
 Mit Bügeleisen  
 verwenden

9 x 8 in.  
 230 x 200 mm

10 sheets  
 feuilles  
 láminas  
 Blatt

CLOVER MFG. CO., LTD.

**4090**  
**Wonder Fuse (9 x 8 in. sheets)**

10 pcs/package	3 packs/box
Package Size	11.81 x 8.78 x 0.1 in

- Lightweight, fusible web.
- Useful for appliqué on apparel, quilts, embroidery, and more.



**4095**  
**Design Pro Appliqué Mat**

1 pc./package	3 packs/box
Package Size	12.8 x 2.52 x 1.8 in

- Non-slip surface texture holds appliqué pieces in place.
- Transparent mat ensures precision placement.
- Non-stick surface texture allows repeated use of fusible materials.

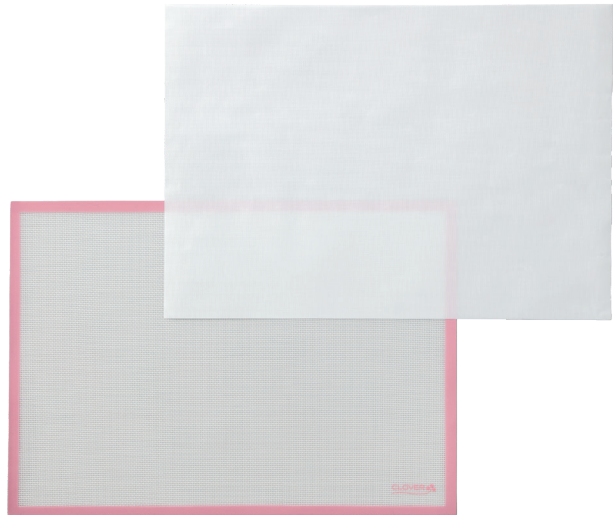

Contents:  
 Appliqué mat: 1  
 Pressing sheet: 1

Instructions for appliqué:



1. Trim fused fabric into desired shapes.

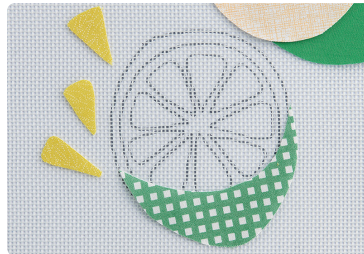

2. Place design under mat and assemble fused pieces.



3. Press pieces in place using pressing sheet.



4. Remove appliqué from the mat.

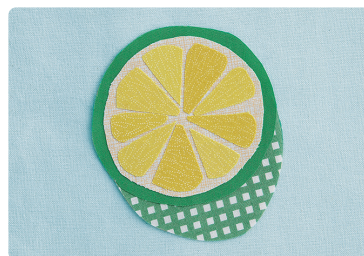

5. Place the appliqué on base fabric and press.



# Sewing & Patchwork Accessories

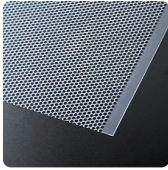

474 <b>Mesh Transfer Canvas</b>	
1 pc./pack	3 packs/box
Package Size	15 x 2.75 x 1 in

The sheet of fine mesh is useful for transferring quilt lines and appliqué design layouts. By using the mesh you don't have to cut out the shape you want to use and trace around.

12 x 16 in

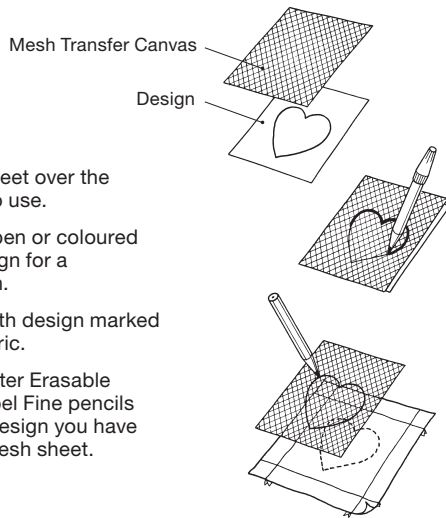

How to use:

- (1) Place the mesh sheet over the design you wish to use.
- (2) Using a ballpoint pen or coloured pen trace the design for a permanent pattern.
- (3) Place the mesh with design marked on it over fabric.
- (4) Using Clover's Water Erasable Makers or Chacopel Fine pencils to trace over the design you have marked on your mesh sheet.



9505 <b>Double Sided Basting Tape</b>	
1 pc./pack	3 packs/box
Package Size	5 x 3.3 x 0.6 in

Quickly and easily adheres to fabric, paper or wood.

Size: 12 mm x 1/2 in

## QUICK BIAS <Fusible Bias Tape>

Easily ironed on to straight or curved fabric designs.

It will eliminate time consumed in making and pinning it in place.

Excellent for use in Stained Glass Quilting, Celtic and Appliqué work or projects.

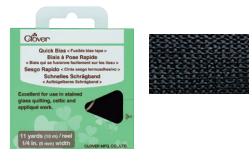

700/BLK <b>QUICK BIAS &lt;Fusible Bias Tape&gt; (Black)</b>	



700/GOLD <b>QUICK BIAS &lt;Fusible Bias Tape&gt; (Gold)</b>	



700/SILVER <b>QUICK BIAS &lt;Fusible Bias Tape&gt; (Silver)</b>	
1 pc./pack	6 packs/box
Package Size	4.3 x 3.6 x 0.3 in

\* Actual colours may vary from printed version.



800/BLK <b>Quick Bias 100 Yards (91 m)</b>	
1 set/pack	3 packs/box
Package Size	7.6 x 7.6 x 0.6 in

# Sewing & Patchwork Accessories

For more efficient craftwork!

Amazing pressing force with just a little effort!

The Roll & Press is a quick and efficient way to make creases or to open and fold seam allowances.

Quick, portable, ergonomic.



7812	
Roll & Press	
1 pc./pack	3 packs/box
Package Size	8.27 x 3.15 1.18 in

Roll to press a seam or fold, either straight, curved or paper pieced seams.



### Convenient in these situations too!

- For laminates and other fabrics that cannot be ironed
- For foundation piecing (paper piecing) and machine piecing
- For making a crease before ironing

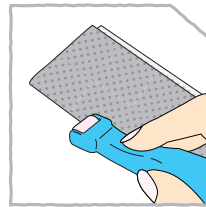

• Crease fabric

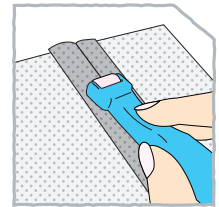

• Fold seam allowance  
• Open seam allowance

### Fabric and hand-friendly.

#### A roller that glides smoothly

- Doesn't pull or distort fabric
- Allows you to press fabrics along straight or curved lines

#### Quick, portable, ergonomic

- Can be held in most comfortable position - left or right handed
- Just a little downward force is all that is needed for significant pressing action.

#### Press small areas with accuracy

- The roller's slight arc allows you to focus pressure on precise areas
- Roller edges will not leave creases on the fabric

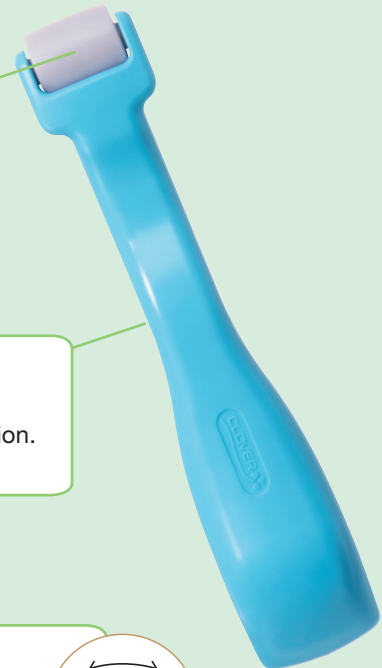
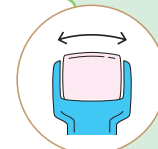

# Sewing & Patchwork Accessories



<b>4053</b>	
<b>Fabric Folding Pen</b>	
	
2 pc./pack	3 packs/box
Package Size	8.66 x 3.35 x 0.87 in

Makes fabric easier to fold.



<b>4054</b>	
<b>Fabric Folding Pen Liquid</b>	
	
1 pc./pack	3 packs/box
Package Size	6.89 x 3.15 x 0.8 in

Hold while sewing or pressing.



<b>7807</b>	
<b>Hold It Precision Stiletto</b>	
	
1 pc./pack	3 packs/box
Package Size	10 x 2.6 x 0.5 in

- Grippy tip for holding fabric.
- Angled tip for good reach and visibility.
- Heat resistant silicone tip for working near iron while pressing.



<b>7803</b>	
<b>Point 2 Point Turner</b>	
	
1 pc./pack	3 packs/box
Package Size	10 x 2.56 x 0.35 in

- Curved end with tip for point turning.
- Fine tipped end for detail work.
- Designed to be comfortable and secure in hand when using either end.



Suitable for making creases and opening and folding the seam allowance of a piece.



<b>495</b>	
<b>Finger Presser</b>	
	
1 pc./pack	3 packs/box
Package Size	7.5 x 1.8 x 0.4 in

Perfect for foundation piecing, patchwork and appliqué.

Made from abrasion-resistant durable material.

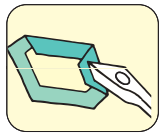
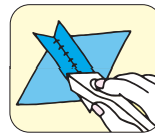
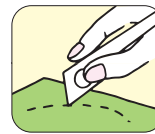
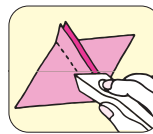

<b>490/NV</b>	
<b>"HERA"™ Marker</b>	
	
1 pc./pack	3 packs/box
Package Size	7.38 x 1.75 x 0.38 in

An easy grip, easy press spatula.

Used for marking and creasing on fabric.



<b>4002</b>	
<b>"HERA"™ Marker for Appliqué &amp; Sewing</b>	
	
1 pc./pack	3 packs/box
Package Size	8.3 x 1.8 x 0.4 in

Usage examples of the spatula

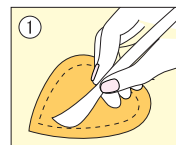

This marker is easy to use for appliqué work and creasing.



For making marks on appliqué and reverse appliqué.

Extra thin tip with curved design.

Usage example of the sharp tip

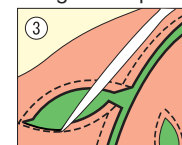

For folding appliqué and reverse appliqué.

# Sewing & Patchwork Accessories

**i sew for fun**  
by Nancy Zieman

**I Sew For Fun Product Line by Nancy Zieman**  
Share a fun creative experience with young, enthusiastic sewists.



**9601**  
**Seam Guide**

1 pc./pack	3 packs/box
Package Size	7 x 3.7 x 0.39 in

Sew accurate seams every time! 5/16 in. (8 mm) thick for easy fabric guiding. Handle grip for ease in attaching and removing. Ideal for straight stitching, curves and top-stitching. Reusable and repositionable adhesive guide underside. Washable adhesive.



**9603**  
**Retractable Seam Ripper**

1 pc./pack	3 packs/box
Package Size	7.28 x 2.56 x 0.47 in

For cutting threads on seams. Use when closed for cutting threads.

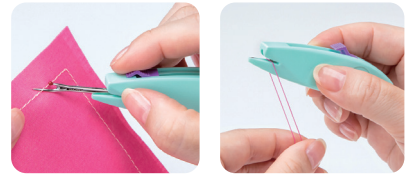

**9605**  
**Hand-Sewing Needles**

1 pc./pack	3 packs/box
Package Size	7.28 x 2.76 x 0.39 in

Adjustable heart-shaped case included. Extra fine high-quality needle.

Includes:

- Milliners No. 5 for heavy weight fabrics
- Betweens No. 5 for normal fabrics
- Embroidery No. 3 for big stitch or embellishment



**9602**  
**Magnet Pin Caddy**

1 pc./pack	3 packs/box
Package Size	7.28 x 5.31 x 1.38 in

Gathers and stores pins safely. Easy pick-up with pins stored in one direction and center grooves. Cover for safe keeping.



**9610**  
**Spring Tape Measure**

1 pc./pack	3 packs/box
Package Size	6.5 x 3.15 x 0.71 in

Retractable with the push of a button. Non-stretch, reinforced fiber glass. 1/16 in. markings for accuracy. Measures 60 in. (150 cm)



**9615**  
**Flexible Rubber Thimble Set**

1 pc./pack	3 packs/box
Package Size	5.91 x 2.56 x 0.79 in

Index and thumb finger sheaths for ease in pulling through fabrics.



# Sewing & Patchwork Accessories

A stitch guide that can be aligned with the edge of the fabric for stitching.



9584	
Stitch Guide	
1 set/pack	3 packs/box
Package Size	7 x 3.7 x 0.47 in

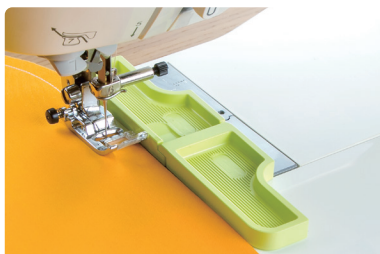

**Note:**  
This guide is suitable for sewing machines of which gap between a needle clamp screw and a needle plate is higher than 8 mm.

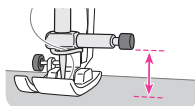

**Comes with a position-adjusting plate!**  
Now the plate can be kept parallel and the guide can be positioned more easily with a hole for a sewing-machine needle.

If the stitch guide is aligned with the fabric before stitching with a sewing machine, a neat stitch with a consistent seam-width can be achieved.

The guide comes with an adhesive sheet that can adhere to both metal and plastic surfaces, enabling it to be fixed at any location.



**Stitching straight**



Use the long side of the guide.

**Stitching curves: Use the short side of the guide.**



Use both guides connected.



Inner curve



Outer curve

**Top Stitching:** place the guide in front of the presser foot and sew.



**Stitching Strips:** with two guides, you can sew strips neatly.



Sandwich with the two stitch guides



9586	
The Ultimate Quilt 'n' Stitch Presser Foot with NANCY ZIEMAN®	
1 set/pack	3 packs/box
Package Size	9 x 3.74 x 1 in

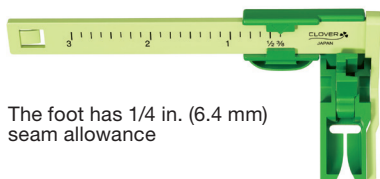

The foot has 1/4 in. (6.4 mm) seam allowance

Move the ruler to set distance between needle and alignment guide 3/8" (9.5 mm) to 3" (76.2 mm).

Your go-to Presser foot for parallel-line stitching and straight line machine quilting. Presser foot with built-in alignment ruler for guiding rows of parallel stitching.

Easily stitch multiple rows without marking every line.



# Sewing & Patchwork Accessories

This sliding gauge is useful in marking seam allowances.

Multipurpose sliding gauge useful for marking.



**9506**  
**5-in-1 Sliding Gauge**

1 pc./pack	3 packs/box
Package Size	9 x 3.88 x 0.25 in

Convenient for drawing seam lines, hem lines, tucks, pleats, buttonholes and other markers where the same dimensions need to be used repeatedly.



**9585**  
**Supersize 5-in-1 Sliding Gauge**  
 with NANCYZIEMAN®

1 pc./pack	3 packs/box
Package Size	14.76 x 4.53 x 0.39 in

A multifunctional 11 inch (279.4 mm) sliding gauge for easy marking!

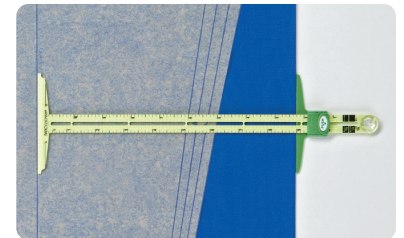

**9579**  
**No-Hassle Triangles Gauge**

1 pc./pack	3 packs/box
Package Size	14.57 x 3.94 x 0.55 in

Create 1/2 square or 1/4 square triangle blocks without ever cutting triangles.

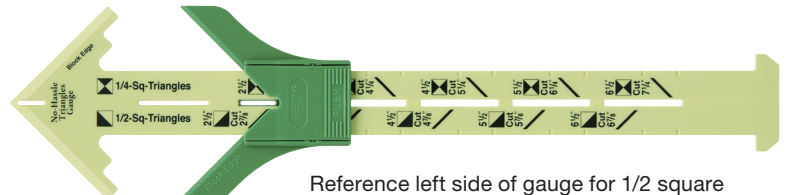
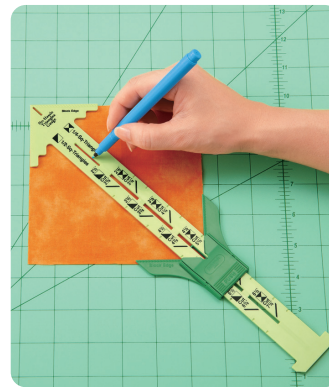
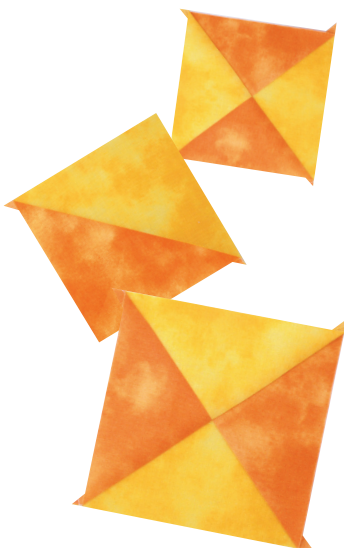

Reference left side of gauge for 1/2 square triangles and right side for 1/4 square triangles.

# Sewing & Patchwork Accessories



9508	
Stack 'n Store Bobbin Tower	
1 set/pack	3 packs/box
Package Size	2.8 x 2.72 x 4.53 in

- Holds most type of bobbin.
- Secures thread ends - no more tangles!
- See thread colours at a glance!
- Convenient and compact!



# Marking Tools

Chaco Liners are perfect for drawing thin lines. Wheel tip for accurate marking on fabric.



NET: 2.2 g approx.



469/B	
Chaco Liner (Blue)	
469/P	
Chaco Liner (Pink)	
469/W	
Chaco Liner (White)	
469/Y	
Chaco Liner (Yellow)	
1 pc./pack	3 packs/box
Package Size	6.1 x 2.9 x 0.8 in

Powder chalk refills for Chaco Liners.



NET (1 pc.): 2.8 g approx.

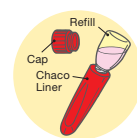

470/B	
Chaco Liner Refill (Blue)	
470/P	
Chaco Liner Refill (Pink)	
470/W	
Chaco Liner Refill (White)	
470/Y	
Chaco Liner Refill (Yellow)	
2 pcs./pack	3 packs/box
Package Size	4.1 x 2.5 x 1 in

# Marking Tools

## A powder chalk which allows you to mark fabric as if you are drawing with a pen

A powder-based chalk for drawing thin, beautiful lines. With its pen-like use, you can make marks as if you are drawing freehand.



**4710**  
Chaco Liner Pen Style (Blue)

**4711**  
Chaco Liner Pen Style (Pink)

**4712**  
Chaco Liner Pen Style (White)

**4713**  
Chaco Liner Pen Style (Yellow)

**4714**  
Chaco Liner Pen Style (Silver)

1 pc./pack	3 packs/box
Package Size	7.5 x 2.4 x 0.6 in

Wheel tip powder chalk. Permits accurate markings for both straight lines and freehand curves.



NET: 2.5 g approx.



### Features of Chaco Liner Pen Style

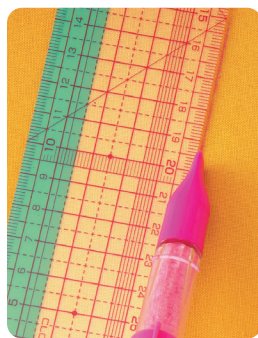

**Marks can be easily made along the ruler**  
You can draw beautiful lines along the ruler with the pointed tip.

**The amount of remaining powder in the pen is visible**  
You can see how much powder you have left through the transparent case.

**Save time on refilling by exchanging the cartridge**  
Powder can be refilled easily by simply exchanging the cartridge. When refilling, the powder will hardly spill over or dirty your hand.

**Smooth touch**  
The shape of the sharp gear tooth, inner parts and powder components were carefully reviewed to achieve a smooth touch.



### Refills for Chaco Liner Pen Styles.



**4720**  
Refill Cartridge for Chaco Liner Pen Style (Blue)

**4721**  
Refill Cartridge for Chaco Liner Pen Style (Pink)

**4722**  
Refill Cartridge for Chaco Liner Pen Style (White)

**4723**  
Refill Cartridge for Chaco Liner Pen Style (Yellow)

**4724**  
Refill Cartridge for Chaco Liner Pen Style (Silver)

1 pc./pack	3 packs/box
Package Size	7.5 x 2 x 0.6 in



NET: 2.5 g approx.

### Easy to Replace!



Comfortable angles (angles that support different hands/situations)  
Approximately 65°  
Comfortable thickness (The shaft is 13.5 mm thick)

**Cross section**  
The powder comes out when the gear tooth is rolled on fabrics due to the vibration from the plate spring.

### Length, thickness and angle that are easy to hold

The length and thickness have been designed to achieve the pen-like ease-of-use.

Also, the chalk can be easily turned around to draw both straight and curved lines freely as it supports many different angles.



# Marking Tools



**418**  
**Chacopel Fine**

0 51221 51456 2

1 set/pack	3 packs/box
Package Size	10.24 x 1.77 x 0.43 in

Fine lines can be clearly marked.

- Contents**
- White: 1 pc.
  - Yellow: 1 pc.
  - Pink/Blue: 1 pc.
  - Sharpener: 1 pc.

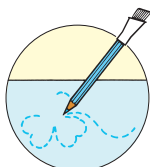

**5003**  
**Water Soluble Pencil (Package of 3)**

0 51221 52310 6

3 pcs./pack	3 packs/box
Package Size	10 x 1.75 x 0.5 in

**5000**  
**Water Soluble Pencil (White)**

0 51221 52307 6

**5001**  
**Water Soluble Pencil (Blue)**

0 51221 52308 3

The Water Soluble Pencils can be easily wiped off with water.

Best suited for precise marking on fabric.

**5002**  
**Water Soluble Pencil (Pink)**

0 51221 52309 0

1 pc./pack	3 packs/box
Package Size	10 x 1.8 x 0.4 in



**5004**  
**Iron-On Transfer Pencil (Red)**

0 51221 52311 3

**5005**  
**Iron-On Transfer Pencil (Blue)**

0 51221 52312 0

1 pc./pack	3 packs/box
Package Size	10 x 1.6 x 0.4 in

Draw designs with the Iron-On Transfer Pencil, and transfer it onto the fabric with an iron.

The traced design can be transferred to fabrics, papers and woodblocks.

**How to use:**

- (1) Place tracing paper on the design that you wish to transfer.
- (2) Trace the design with the Iron-On Transfer Pencil.
- (3) Place the traced design on the fabric and iron. The traced design will appear on the fabric.



For transferring the appliqué and doll designs.



Easy transfer with an iron. The traced design can be used for 2-3 times.



**434**  
**Tracing Paper "Clover Chacopy"**

0 51221 51343 5

5 sheets/pack	3 packs/box
Package Size	12.9 x 5.3 x 0.5 in

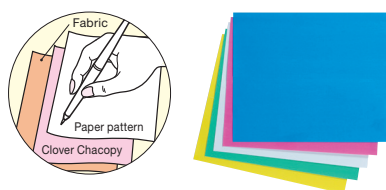

Size: 12 x 10 in.

**432/B**  
**Triangle Tailor's Chalk (Blue)**

0 51221 51215 5

**432/W**  
**Triangle Tailor's Chalk (White)**

0 51221 51217 9

**432/Y**  
**Triangle Tailor's Chalk (Yellow)**

0 51221 51218 6

**432/R**  
**Triangle Tailor's Chalk (Red)**

0 51221 51216 2

1 pc./pack	3 packs/box
Package Size	3.4 x 2.5 x 0.4 in



Tailor's Chalk is available in four colors.

# Marking Tools

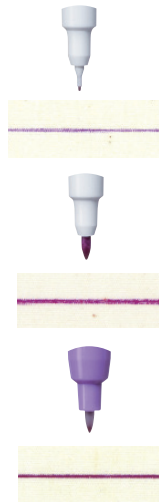

<Extra Fine>  
 Markings naturally disappear in 2 - 7 days.

<Thick>  
 Markings naturally disappear in 4 - 14 days.

<Fine>  
 Markings naturally disappear in 4 - 14 days.

**5030**  
**Air Erasable Marker (Purple Extra Fine)**

0 51221 75030 4

**5031**  
**Air Erasable Marker (Purple Thick)**

0 51221 75031 1

**5032**  
**Air Erasable Marker with Eraser (Purple Fine)**

0 51221 75032 8

1 pc./pack	3 packs/box
Package Size	8.27 x 1.69 x 0.43 in



**517**  
**White Marking Pen (Fine)**

0 51221 52303 8

1 pc./pack	3 packs/box
Package Size	8.27 x 1.7 x 0.47 in

A white marker perfect for marking black and dark-coloured fabrics. Markings disappear when washed or ironed.

The white ink stands out on black and dark-coloured fabric.



**5012**  
**Chacopen Pink with Eraser (Air Erasable)**

0 51221 52318 2

1 pc./pack	3 packs/box
Package Size	7.4 x 1.5 x 0.5 in

Marks will fade out over time (within 2-10 days).

Comes with a convenient "Eraser Pen" for immediate erasure of unwanted marks.



**515**  
**Water Erasable Marker (Fine)**

0 51221 52301 4

**516**  
**Water Erasable Marker (Thick)**

0 51221 52302 1

1 pc./pack	3 packs/box
Package Size	7.6 x 1.6 x 0.4 in

Markings can be quickly removed with water.



**5013**  
**Chacopen Blue with Eraser (Water Erasable)**

0 51221 52319 9

1 pc./pack	3 packs/box
Package Size	7.4 x 1.5 x 0.5 in

Water Erasable.

Comes with a convenient "Eraser Pen" for immediate erasure of unwanted marks.

Fine

Thick



**518**  
**Eraser Pen**

0 51221 52304 5

1 pc./pack	3 packs/box
Package Size	7.38 x 1.5 x 0.5 in

Used to remove markings made by Water Erasable Markers.

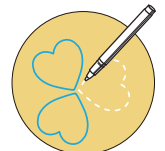

# Marking Tools

## Marking tool use and method of erasure

★ Make sure to always test the tools (by marking and erasing) on an edge of the cloth before use.

◎ = optimal / ○ = suitable / △ = usable

Art No.		5030, 5031, 5032	515, 516, 5013	517	418	5000, 5001, 5002, 5003
Product image						
Usage	Sewing	◎	◎	◎	◎	◎
	Patchwork	○	○	○	○	
	Embroidery	○	○	○		○
Method of erasure	Disappears over time	◎ *4 to 14 days				
	Spray with water	◎	◎			○
	Wash with water	◎	◎	◎	△	◎
	Use an erasing pen	◎	◎			
	Heat from an iron			◎		
	Use a brush				△	
Remarks		- Pen type - For white and light-colored fabric * Art No. 5030 markings will disappear in about 2 to 7 days.	- Pen type - For white and light-colored fabric	- Pen type - For black and dark-colored fabric	- Pencil type	- Pencil type - A soft lead makes it easy to apply - Can also be used on felt

Art No.		4710, 4711, 4712, 4713, 4714	469/B, 469/P, 469/W, 469/Y	432/B, 432/W, 432/Y, 432/R	434	5004, 5005
Product image						
Usage	Sewing	◎	◎	◎	◎	Applique, stuffed animals
	Patchwork					
	Embroidery				○	
Method of erasure	Disappears over time			Does not disappear		Does not disappear
	Spray with water					
	Wash with water	△	△		◎	
	Use an erasing pen					
	Heat from an iron					
	Use a brush	△	△			
Remarks		- Powder type - Avoid heat sources such as ironing	- Powder type - Avoid heat sources such as ironing	- Avoid heat sources such as ironing		- Pencil type - For white and light-colored fabric

# Silk Threads

*Velvety smooth with a glossy shine.*

They are flexible and strong and will not twist or curl in use.  
Can be used for applique, hand sewing, quilting, and embroidery.

701 Silk Threads	
Description	44 colors available
	100% Silk Thread
	109 yards
1 spool/pack	6 packs/box
Packaging Size	1.5 x 1 x 1 in

\* Actual colours may vary from printed version.

	701/155 Red 0 51221 51068 7
	701/010 Cherry 0 51221 51005 2
	701/011 Cranberry 0 51221 51006 9
	701/064 Maroon 0 51221 51033 5
	701/055 Clay 0 51221 51029 8
	701/149 Fresh 0 51221 51063 2
	701/061 Shrimp 0 51221 51032 8
	701/074 Harvest Gold 0 51221 51034 2
	701/075 Light Gold 0 51221 51035 9
	701/029 Golden Rod 0 51221 51013 7

	701/096 Chartreuse 0 51221 51041 0
	701/146 Light Kelly 0 51221 51062 5
	701/084 Churchill Green 0 51221 51038 0
	701/118 Holly Green 0 51221 51049 6
	701/154 Cedar 0 51221 51067 0
	701/035 Emerald 0 51221 51016 8
	701/139 Dark Jade 0 51221 51059 5
	701/153 Light Spruce 0 51221 51066 3
	701/138 Jade Blue 0 51221 51058 8
	701/137 Pale Jade 0 51221 51057 1
	701/152 Deep Aqua 0 51221 51065 6
	701/151 Turquoise 0 51221 51064 9

	701/107 Colonial Blue 0 51221 51044 1
	701/009 French Navy 0 51221 51004 5
	701/057 Purple 0 51221 51031 1
	701/005 Lilac 0 51221 51003 8
	701/051 Blue Gray 0 51221 51026 7
	701/053 Amethyst 0 51221 51028 1
	701/157 Plum 0 51221 51069 4
	701/143 Magenta 0 51221 51060 1
	701/030 Medium Pink 0 51221 51014 4
	701/014 Light Pink 0 51221 51007 6



# Silk Threads

	701/205 Gray
	701/401 White
	701/403 Winter White
	701/041 Linen
	701/042 Egg Shell
	701/043 Beige
	701/039 Taupe
	701/117 Dark Brown
	701/402 Black
	701/120 Lead
	701/021 Steel
	701/052 Light Aqua



701/BWE	
Silk Thread Asst. 2 ea. (#401, 402, 403)	
6 spools/pack	1 pack/box
Package Size 6.6 x 1.5 x 1 in	



# Scissors

## Bordeaux Ultimate Scissors

Innovative technique ensures a fine cut and unsurpassed durability.

These small, portable stainless-steel scissors can smoothly cut thick or multiple layers of fabric. With strong, durable blades and soft-to-grip handle, the scissors ensures a fine cut.

**Bordeaux**

- Sharpness and durability**  
 Sharpness and durability are achieved by precision grinding of high quality stainless steel. This allows us to cut thick, dense or multiple layers of fabric easily and with precision.
- Durable blades**  
 Scissors with highly durable blades made of high-quality stainless steel treated with a hardening process.
- Easy-to-grip handle**  
 The easy-to-grip handle is designed to minimize the fatigue associated with numerous or long cuts. The handle is ambidextrous.
- Genuine leather sheath included**



**4940**  
**Bordeaux Ultimate Scissors 130**  
 with **NANCYZIEMAN®**

1 pc./pack	3 packs/box
Package Size	9.45 x 3.78 x 0.49 in

Superior quality for scissors of this size. Turn around easily with small blades.



**4941**  
**Bordeaux Ultimate Scissors 170**  
 with **NANCYZIEMAN®**

1 pc./pack	3 packs/box
Package Size	9.45 x 3.78 x 0.49 in

Handy size. Fine cuts even when aligning piece cuts and seam allowances.



# Scissors

## Patchwork Scissors



**493/L**  
Patchwork Scissors  
(Large)

1 pc./pack	3 packs/box
Package Size	11.6 x 4 x 1 in

Made from top-grade stainless steel, sharp and durable excellent for cutting multiple layers of fabric.



9.5 in



**493**  
Patchwork Scissors

1 pc./pack	3 packs/box
Package Size	9.1 x 3.3 x 0.5 in

Perfect for cutting multiple layers of fabric or cutting pieces for quilting. A cover is included for safe and easy handling and storage.



7 in



**493/S**  
Patchwork Scissors  
(Small)

1 pc./pack	3 packs/box
Package Size	7.4 x 2.5 x 0.4 in

Perfect for cutting appliqué pieces for quilting and sewing.



5.5 in

### 493/L, 493, 493/S

The finely serrated blades will grip the fabric firmly for a precision cut.

Perfect for cutting multiple layers of fabric as well as quilt batting.

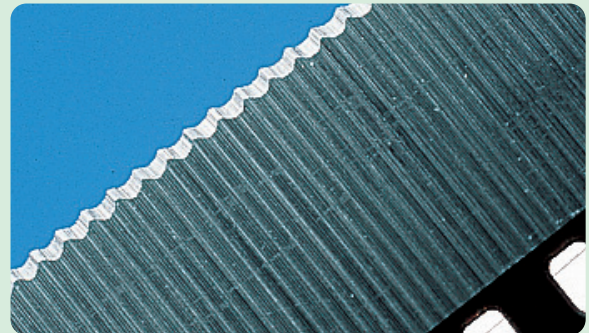

### Perfect for fine cutting.



**493/CW**  
Patchwork Scissors  
(Mini)

1 pc./pack	3 packs/box
Package Size	7.3 x 2.9 x 0.5 in

The pointed tip is perfect for fine cutting and trimming. Used for chenille quilting, appliqué, sewing and crafts. Heavy duty blades make it easy to cut through several layers of fabric.



4.5 in

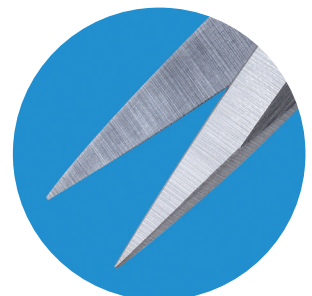

# Rotary Cutters

Perfect cutter for patchwork requiring accuracy

Rotary cutters are the ultimate in simplicity and functionality. Fits into your hand perfectly and allows for accurate and speedy cuts.

## Features of Clover Rotary Cutter

Hold upright



At an angle



### Cuts beautifully regardless of how you hold it

Cuts beautifully regardless of how you hold it, whether held upright or at an angle as the cover opens at a tilt, due to the wide cutting range with just the right amount of blade exposed.

### An easy grip handle that fits into your hand perfectly

The "Soft Cushion Handle" gently supports your palm and fingers for a comfortable cutting experience. For speedy and accurate cuts with a cutter that fits into your hand perfectly.

*\*Can be used for both left and right handed users*

Can be used by both right and left hand by simply turning the safety cover around.

\*The cutter is initially set to right-hand use.

### Adjustable rotation speed

Rotation speed can be adjusted with the tightening screw at the back.

The blade will rotate slower when the screw is tightened allowing for cutting thick or multiple layers of fabric beautifully.

Cover opens at a tilt!

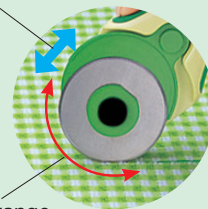

Wide cutting range

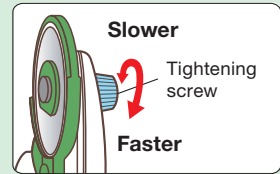

<b>7500</b>	
Rotary Cutter (45 mm)	
0 51221 52250 5	
1 pc./pack	3 packs/box
Package Size	9 x 4.38 x 0.88 in



<b>7502</b>	
Rotary Cutter (60 mm)	
0 51221 52252 9	
1 pc./pack	3 packs/box
Package Size	10.63 x 4.75 x 1.13 in



<b>7501</b>	
Rotary Cutter (28 mm)	
0 51221 52251 2	
1 pc./pack	3 packs/box
Package Size	9 x 4.13 x 1.13 in



<b>7503</b>	
Rotary Cutter (18 mm)	
0 51221 52253 6	
1 pc./pack	3 packs/box
Package Size	9.13 x 3.13 x 0.75 in



# Rotary Cutter Blades

**Clover Rotary Blade Refills make blade replacement safe, quick and easy.**  
Blades come in a protective cover for safe handling.

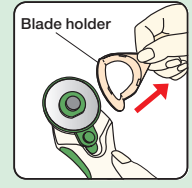
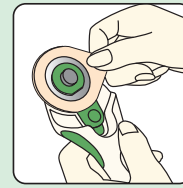

45 mm

**7508**  
**Clover Rotary Blade Refill**  
**(45 mm/1 pc.)**

0 51221 52258 1

1 pc./pack	3 packs/box
Package Size	6.3 x 2.88 x 0.25 in



60 mm

**7510**  
**Clover Rotary Blade Refill**  
**(60 mm/1 pc.)**

0 51221 52266 6

1 pc./pack	3 packs/box
Package Size	7.88 x 3.38 x 0.13 in



28 mm

**7514**  
**Clover Rotary Blade Refill**  
**(28 mm/2 pcs.)**

0 51221 52264 2

2 pcs./pack	3 packs/box
Package Size	6.25 x 2.75 x 0.25 in



18 mm

**7512**  
**Clover Rotary Blade Refill**  
**(18 mm/2 pcs.)**

0 51221 52268 0

2 pcs./pack	3 packs/box
Package Size	6.25 x 2.75 x 0.63 in



45 mm

**7509**  
**Clover Rotary Blade Refill**  
**(45 mm/5 pcs.)**

0 51221 52259 8

5 pcs./pack	3 packs/box
Package Size	6.3 x 3.23 x 0.71 in

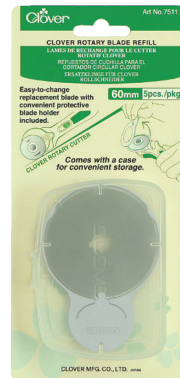

60 mm

**7511**  
**Clover Rotary Blade Refill**  
**(60 mm/5 pcs.)**

0 51221 52267 3

5 pcs./pack	3 packs/box
Package Size	7.87 x 3.86 x 0.79 in



28 mm

**7515**  
**Clover Rotary Blade Refill**  
**(28 mm/5 pcs.)**

0 51221 52265 9

5 pcs./pack	3 packs/box
Package Size	6.25 x 2.75 x 0.63 in



18 mm

**7513**  
**Clover Rotary Blade Refill**  
**(18 mm/5 pcs.)**

0 51221 52269 7

5 pcs./pack	6 packs/box
Package Size	6.25 x 2.88 x 0.63 in

# Slash Cutter

Make beautiful slash quilts quickly!



499	
Slash Cutter	
1 set/pack	3 packs/box
Package Size	9.1 x 3.8 x 1.1 in

Comes with two interchangeable guides; for straight slash cutting and curved slash cutting. Designed with comfort and safety features!

\*This cutter only supports Clover's replacement blades.



Straight slash cutting      Curved slash cutting

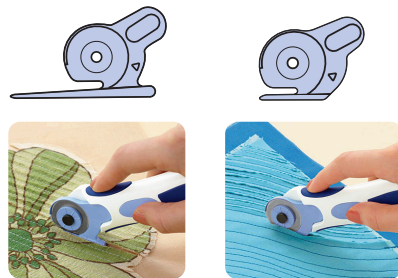

## Quilting method with beautiful layers of colour and soft texture

*Making slash quilting fun, beautiful and easy.*

Slash quilting is a method of quilting. In this method, multiple layers of fabric are arranged on top of a base fabric and are sewn parallel to the true bias direction.

Then, seams of all layers but the bottom layer are cut through and washed, and the fabric of the openings is raised.

Slash quilting is known for its beautiful layers of colour and soft texture.

Slash quilting can be done easily and quickly with Clover's Slash Cutter.



Insert into a channel between two stitching lines and push forward.



Fabric will be cut as you push the cutter forward.

## Features of Clover Slash Cutter

*The ratchet mechanism to firmly fix the blade in place*

The ratchet mechanism to prevent the blade from rotating when it is being pushed.

As the blade doesn't rotate, the fabric won't get caught in between the blade and the guide, allowing for smooth cutting of several layers of fabric.

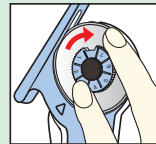

*16-step pitch feeding to maintain cutting quality*

Turn 1 pitch once the blade becomes dull to improve cutting quality.

It is designed so that it is easy to tell when to replace the blade.

*The cutter comes with a guides for both straight/curved*

It works with both types of slash quilts by switching the interchangeable guides.

Both for stitching intervals wider than 6 mm.

## Basic technique of slash quilting and how to use a Slash Cutter:

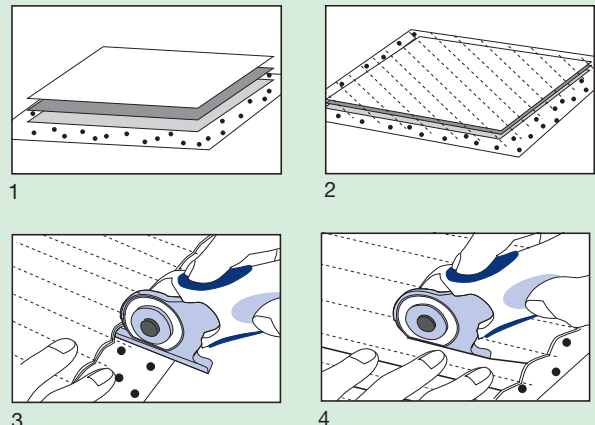

1. Layer pieces of fabric so that the fabric grain is aligned. Select a piece of fabric that has a surface which raises easily as the middle layer, and place a larger piece of fabric as the bottom layer for easy cutting.
2. With a sewing machine, make seams with a fixed width in the true bias direction (in a 45 degree angle to the fabric grain).
3. Insert the Slash Cutter guide in between the seams. (Place the guide on top of the bottom layer.)
4. Hold the fabric down with one hand and push the Slash Cutter forward to cut. (Make a cut with scissors if it is hard to cut at the beginning)
5. Once all the cutting is done, wash with a washing machine and raise fabric. Dry and add the finishing touches to complete.

# Fabric Tube Maker

Accomplishes two precision folds in one effortless motion.

The Fabric Tube Maker makes creating Jelly Roll® projects a breeze, by inserting fabric and batting strips through parts, which are then effortlessly pulled through the tube maker!



1 set/pack	3 packs/box
Package Size	5.31 x 2.36 x 1.34 in

Create jelly roll rugs, baskets, and more!



1. Place batting on top of wrong side of fabric.



2. Insert fabric and batting strips through part A. Place part B in fabric and batting and click into place with part A. Pull fabric and batting through parts A/B.

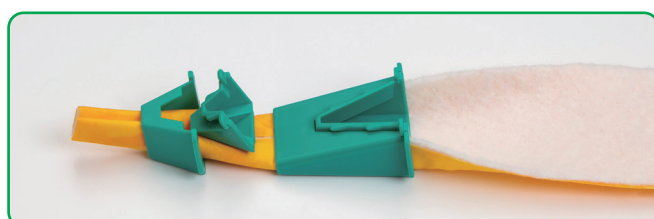

3. Insert folded fabric and batting strips into part C to fold again. Place part D on the top of the fabric and batting strips and click into with part C.

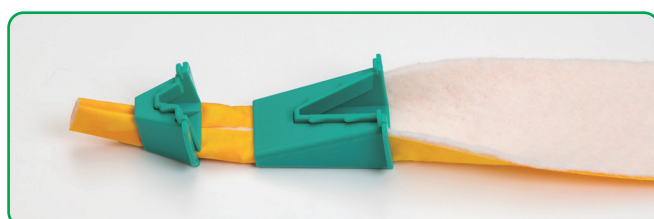

4. Pull the fabric and batting strips through parts C/D. Keep the position of paired units A/B and C/D close to the needle plate and slide along as you sew.



Pair parts A/B and C/D should be combined.

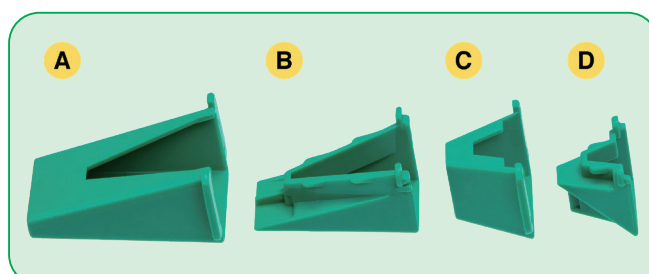

Made of durable and extremely smooth plastic material.

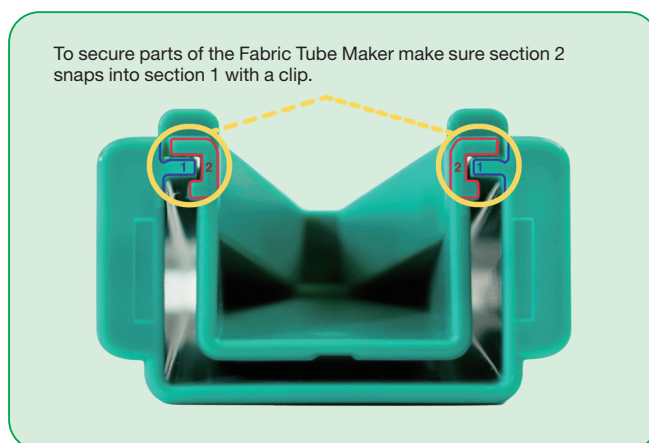

# Tape Makers

## Bias Tape Makers

Make bias tapes in minutes!



464/06

**Bias Tape Maker  
(1/4 in)**



1 pc./pack

3 packs/box

Package Size

6.75 x 3 x 0.75 in



464/12

**Bias Tape Maker  
(1/2 in)**



1 pc./pack

3 packs/box

Package Size

6.75 x 3 x 1 in



464/18

**Bias Tape Maker  
(3/4 in)**



1 pc./pack

3 packs/box

Package Size

6.75 x 3 x 1 in



464/25

**Bias Tape Maker  
(1 in)**



1 pc./pack

3 packs/box

Package Size

6.75 x 3 x 1 in



464/50

**Bias Tape Maker  
(2 in)**



1 pc./pack

3 packs/box

Package Size

6.75 x 3 x 1.5 in

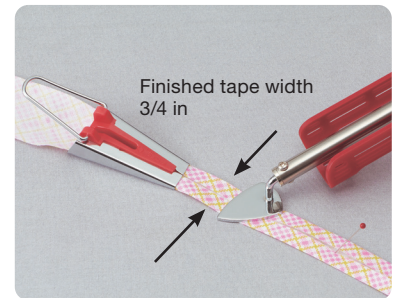

Insert the fabric through the bias tape maker and iron.

**How to use:**

- (1) Cut the fabric according to size.
- (2) Insert the fabric through the tape maker.
- (3) Pin the fabric edge and iron the folded tape as you pull the tape maker.

*You can quickly make bias tapes of the same width using the same fabric for belt loops and the piping finishing of armholes and necklines.*



464/06  
1/4 in



464/12  
1/2 in



464/18  
3/4 in



464/25  
1 in



464/50  
2 in

# Tape Makers

## Fusible Bias Tape Makers

From Celtic Quilt appliqué to temporary piping tapes, this tape maker will expand the creativity of your work.



<b>4011</b>	
<b>Fusible Bias Tape Maker (1/4 in)</b>	
1 pc./pack	3 packs/box
Package Size	6.3 x 2.76 x 1 in



<b>4012</b>	
<b>Fusible Bias Tape Maker (3/8 in)</b>	
1 pc./pack	3 packs/box
Package Size	6.3 x 2.76 x 1 in



<b>4013</b>	
<b>Fusible Bias Tape Maker (1/2 in)</b>	
1 pc./pack	3 packs/box
Package Size	6.3 x 2.76 x 1 in



<b>4014</b>	
<b>Fusible Bias Tape Maker (3/4 in)</b>	
1 pc./pack	3 packs/box
Package Size	6.3 x 2.76 x 1 in



<b>4015</b>	
<b>Fusible Bias Tape Maker (1 in)</b>	
1 pc./pack	3 packs/box
Package Size	6.3 x 2.76 x 1.6 in

By using a 5 mm-wide Fusible Web with this 18 mm-wide tape maker, you can make bias tapes for piping which can baste fabric.

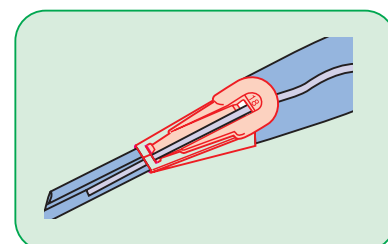

\*You can also make bias tapes without heat adhesive tapes.

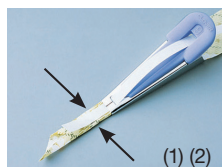

### How to use:

- (1) Insert the Fusible Web (Heat Adhesive Tape) in the upper groove.
- (2) Insert bias cut fabric in the lower groove.
- (3) Pull both materials at the same time and iron.
- (4) Remove the adhesive tape and apply.

Finished tape width 3/8 in

## Fusible Web

This tape is convenient for holding Celtic quilt, stained glass quilt and appliqué in place.



4031



4032

<b>4031</b>	
<b>Fusible Web (1/4 in width/40 ft. roll)</b>	
<b>4032</b>	
<b>Fusible Web (3/4 in width/40 ft. roll)</b>	
1 pc./pack	3 packs/box
Package Size	6 x 3.5 x 0.6 in

The Fusible Web is a heat adhesive tape in the shape of a spider web that will keep the fabric soft and maintain its touch.



Width of the corresponding Fusible Web  
6/9 mm width: 1/4 in  
12/18/25mm width: 3/4 in

# Mini Iron & Accessories

This small, light iron is very easy to handle and can be used to press small areas.

It features a safety cover and switch on the handle to protect hands and fingers.

**Pilot lamp**  
You can tell the power is on with one look.

**2-step heat control**

**Handy switch**  
It also features a dial for heat control and an on/off switch on the handle.

**Thick handle**  
It fits into your hand comfortably for smooth craft work.

**Safety cover**  
Protects hands and fingers coming into contact with the heated conductor.

**Small iron tip**  
Able to press only the necessary areas.

**Comes with an iron stand**

## 9100

Mini Iron II™ "The Adapter"



1 set/pack	3 packs/box
Package Size	15 x 5.13 x 1.5 in

## 9101

Mini Iron II™ "The Adapter Set"



1 set/pack	3 packs/box
Package Size	16.75 x 9.81 x 1.88 in

## MCI-900

Mini Iron



1 set/pack	3 packs/box
Package Size	14.4 x 4.6 x 4.6 in



Convenient not only for patchwork and quilt but also for sewing and other various handicrafts.



For Celtic quilts



For mesh work



For making appliqué



For folding seam allowance

## Interchangeable tips are sold separately

Mini Iron II has special interchangeable tips that can be used for Quilting, Sewing and Crafting. The Mini Iron II has four adaptable tips to be used for doll making, paper crafting and hard to reach corners.

9103

The Large Iron Tip works well on large projects.

9105

The Slim Line Tip is perfect for working on seams or fabric folding projects.

9107

Use these hot knife blades with the Mini Iron II to cut fabric with heat, requiring a sharp cutting edge along with heat to seal the edges after cutting.

## 9103

Adapter Iron Tip (Large)



## 9105

Adapter Slim Line Tip



1 pc./pack	3 packs/box
Package Size	7.75 x 3 x 1.38 in

## 9107

Adapter Hot Knife Tip Blade Refill



1 pc./pack	3 packs/box
Package Size	7.75 x 3 x 0.38 in

# Embroidery Stitching Tools

Embroider easily by simply thrusting the needle into the fabric!

Enjoy perfectly aligned stitches.



<b>8800</b>	
<b>Embroidery Stitching Tool</b>	
1 set/pack	3 packs/box
Package Size	8.62 x 3.63 x 0.88 in

\*Package includes Embroidery Stitching Tool, one 3-ply needle and one needle threader.



Place the fabric with the design in an embroidery hoop and stitch with a needle as if you are drawing a picture.

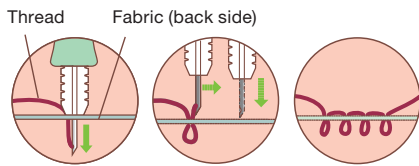

Make a variety of stitches by thrusting the needles into the fabric in the same way.

### Back stitch



Thrust the needle into the fabric surface.

Thrust needle in the direction of stitching.

### Satin stitch



Thrust the needle into the fabric surface.

Thrust needle as if filling the surface.

### Loop stitch

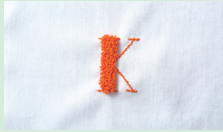

Thrust needle from the back of the fabric.

Thrust needle while enjoying the three-dimensional look.

### Velvet-like



Thrust needle from the back of the fabric.

Cut the end of the loop with scissors.



<b>8801</b>	
<b>Embroidery Stitching Tool Needle Refill (Single Ply Needle)</b>	



1 pc./pack	3 packs/box
Package Size	8.75 x 2.25 x 0.25 in

<b>8802</b>	
<b>Embroidery Stitching Tool Needle Refill (Needle for Medium-Fine Yarn)</b>	



1 pc./pack	3 packs/box
Package Size	8.75 x 2.25 x 0.25 in

<b>8803</b>	
<b>Embroidery Stitching Tool Needle Refill (6 Ply Needle)</b>	



1 pc./pack	3 packs/box
Package Size	8.63 x 2.13 x 0.25 in

<b>8804</b>	
<b>Embroidery Stitching Tool Needle Refill (3 Ply Needle)</b>	



1 pc./pack	3 packs/box
Package Size	8.63 x 2.25 x 0.25 in

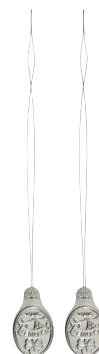
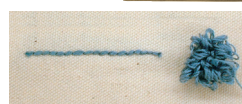
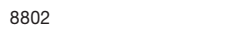

<b>8810</b>	
<b>Embroidery Stitching Tool Needle Threader</b>	



2 pcs./pack	3 packs/box
Package Size	8.63 x 2.25 x 0.13 in

Convenient threader for the Embroidery Stitching Tool.

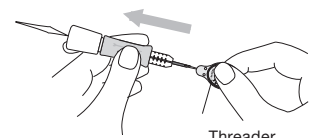

Threader

# Embroidery Stitching Tools

Perfect for Embroidery Stitching.

Inner hoop grips the fabric firmly, keeping it tight.



**8812**  
**Clover Embroidery Hoop (7 in)**

1 pc./pack	3 packs/box
Package Size	9 x 8.13 x 0.75 in

**8813**  
**Clover Embroidery Hoop (4 3/4 in)**

1 pc./pack	3 packs/box
Package Size	8.63 x 5.88 x 0.5 in

Tighten hoop by turning metal dial. Keeps the thread from wrapping around the screw.

The Clover Embroidery Hoop consists of an inner and outer hoop.

Outer hoop  
 Fabric  
 Edge of the inner hoop  
 Cross-section view

## "Kantan Couture" Bead Embroidery Tools



This old art of embroidery using a fine hook on a fine cloth stretched in frame is called "Tambour", reborn with Clover's "Kantan Couture" Bead Embroidery Tool.

Basic techniques with this tool can create beautiful motifs using sequins and beads. Embellish/Design and make it your own.

Your imagination possibilities are endless.



**9900**  
**"Kantan Couture" Bead Embroidery Tool**

1 set/pack	3 packs/box
Package Size	8.63 x 3.63 x 0.88 in

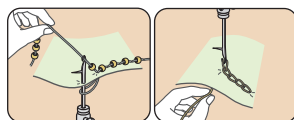

Beads and sequins are easily applied. Chain-stitching is a breeze.



**9901**  
**"Kantan Couture" Bead Embroidery Tool Needle Refill**

1 pc./pack	6 packs/box
Package Size	5.5 x 2.38 x 0.06 in

Replacement needle exclusively for Bead Embroidery Tool.

Easy replacement with a screw on the handle.



# Stitch Dome

For easy and speedy embroidery and hemstitching!



1 set/pack	3 packs/box
Package Size	5.5 x 3.46 x 0.83 in

Contents: Stitch Dome, Rubber Band



Diameter: approx. 3 3/8 in.  
Height: approx. 11/16 in.

Embroidery



Appliqué



Sewing



"Wonder Clips" is not included in the set.

The secret to its ease of use

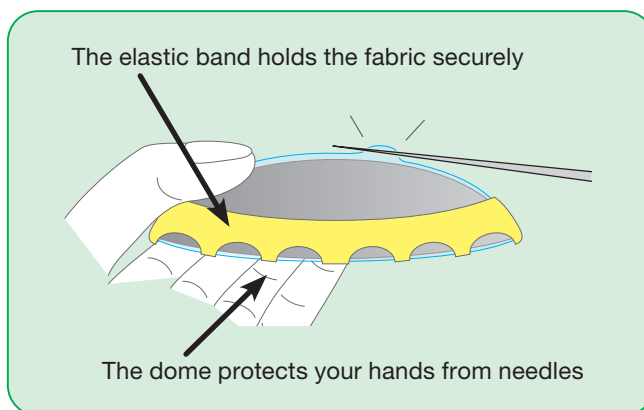

How to Use:

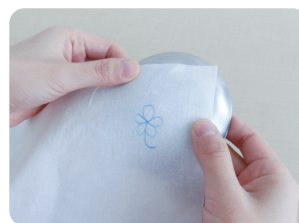

1. Place the Stitch Dome under the fabric.

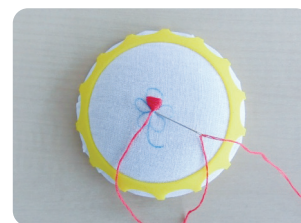

2. Fix the fabric with the elastic band, work on your embroidery or hemstitching using the surface of the Stitch Dome.

# Punch Needle and Hoop

Just like painting with yarn!



1 pc./pack	3 packs/box
Package Size	7.72 x 2.36 x 1 in

Contents: Punch needle, Ring, Tapestry needle and String (for threader)

Comes with adjusting rings to ensure a secure needle length setting.

Suitable for medium to bulky weight yarn.



Easily create or re-create any design with a yarn threaded needle!

Spacer rings	1 in	2.5 cm
	1-3/8 in	3.5 cm
	1-3/4 in	4.5 cm
	2-3/16 in	5.5 cm

The size of the loop can be adjusted by using handle spacer rings to set needle length.



1 pc./pack	3 packs/box
Package Size	9.17 x 7.8 x 1.9 in

Made with sturdy ABS resin and steel closures.

No bending, warping, or loosening.



Just "punch" the yarn threaded needle into your fabric and follow your pattern.

Suitable for medium to bulky weight yarn.



A height adjustable hoop that keeps fabric securely in place for punch needle work.

Please attach the legs when working with a needle that is 4.5 cm or longer.

# Pom-Pom Makers

Beautiful Pom-Poms Made Easy!

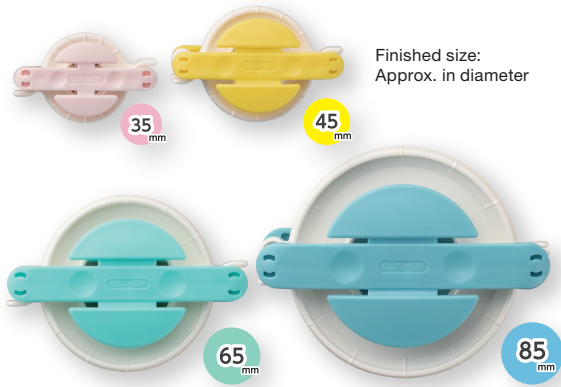

Finished size:  
Approx. in diameter



**3129**  
**Pom-Pom Maker Set**



4 pcs./pack	3 packs/box
Package Size	8.66 x 5.12 x 1.38 in

Includes 4 Pom-Pom Makers in different sizes with new specifications!

Finished size: Approx. 1 3/8", 1 1/2", 2 1/2", 3 3/8" inches in diameter



**3124**  
**Pom-Pom Maker (Small)**



2 pcs./pack	3 packs/box
Package Size	8.63 x 3.25 x 1.38 in

Finished size: Approx. 1 3/8", 1 1/2" inches in diameter



**3126**  
**Pom-Pom Maker (Large)**



2 pcs./pack	3 packs/box
Package Size	8.63 x 4.13 x 1.5 in

Finished size: Approx. 2 1/2", 3 3/8" inches in diameter

## How to Use:

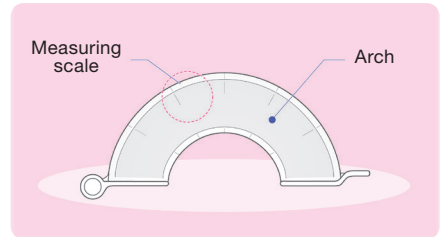

The measuring scale on the arch makes it easy to create multi-colored pom-pom.

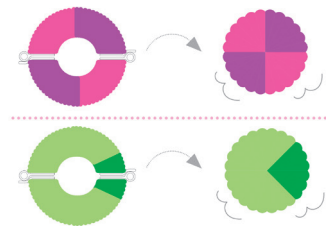

# Pom-Pom Makers



**3127**  
**Pom-Pom Maker (Extra Small)**

2 pcs./pack	3 packs/box
Package Size 6.5 x 2.75 x 0.88 in	

Finished size:  
 Approx. 3/4 inches  
 in diameter



**3128**  
**Pom-Pom Maker (Extra Large)**

1 pc./pack	3 packs/box
Package Size 8.63 x 5.63 x 2.25 in	

Finished size:  
 Approx. 4 1/2 inches  
 in diameter



# Tassel Makers

**Create tassels with your favorite threads!**

Easily make tassels with embroidery thread, woolen yarns and others.



**9940**  
**Tassel Maker (Small)**

1 pc./pack	3 packs/box
Package Size 8.66 x 5.71 x 0.79 in	

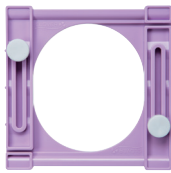

**9941**  
**Tassel Maker (Large)**

1 pc./pack	3 packs/box
Package Size 8.66 x 6.3 x 0.79 in	

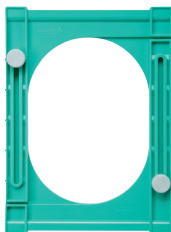

### How to Use:



# “QUICK” Yo-Yo Makers

Quick and easy Yo-Yo Maker templates!

“QUICK” Yo-Yo Makers allow you to make evenly spaced stitches to create beautiful gathers. Fold the seam allowance, rounding off to make a nicely shaped yo-yo.



8702	
“QUICK” Yo-Yo Maker (Extra Small)	
1 set/pack	3 packs/box
Package Size	8.63 x 3.88 x 0.25 in



8700	
“QUICK” Yo-Yo Maker (Small)	
1 set/pack	3 packs/box
Package Size	8.63 x 3.88 x 0.25 in



8701	
“QUICK” Yo-Yo Maker (Large)	
1 set/pack	3 packs/box
Package Size	8.63 x 4.25 x 0.38 in



8703	
“QUICK” Yo-Yo Maker (Extra Large)	
1 set/pack	3 packs/box
Package Size	8.69 x 5.5 x 0.38 in



### How to Use:

- Place the fabric between the plates and cut off the seam allowance leaving 3-5 mm.
- Stitch following the holes in the plates.
- Remove the plates and gather the thread.
- Gather tightly, knot the end and hide it by placing it inside.
- Round off to a nice shape and voilà!



8708	
“QUICK” Yo-Yo Maker (Jumbo)	
1 set/pack	3 packs/box
Package Size	9.13 x 7.88 x 0.38 in

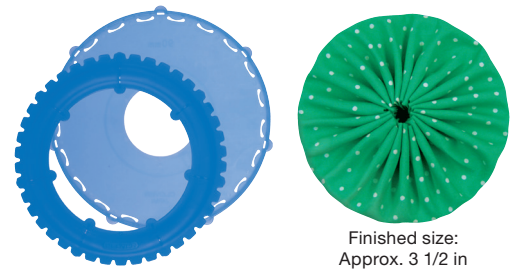

# Kanzashi Flower Makers

Simply set, cut and sew to create beautiful Kanzashi Flowers!

Kanzashi is a traditional Japanese art form of folding and stitching fabric petals for use in beautiful hair adornments.



Finished size:  
Approx. 2 in



Finished size:  
Approx. 3 in



Finished size:  
Approx. 3 in

<b>8484</b>	
<b>Kanzashi Flower Maker (Gathered Petal/Small Size)</b>	
1 pc./pack	3 packs/box
Package Size	8.63 x 4 x 0.13 in

<b>8485</b>	
<b>Kanzashi Flower Maker (Gathered Petal/Large Size)</b>	
1 pc./pack	3 packs/box
Package Size	8.75 x 4.38 x 0.13 in

<b>8483</b>	
<b>Kanzashi Flower Maker (Pointed Petal/Large Size)</b>	
1 pc./pack	3 packs/box
Package Size	8.75 x 4.38 x 0.13 in



Finished size:  
Approx. 2 in



Finished size:  
Approx. 3 in

<b>8486</b>	
<b>Kanzashi Flower Maker (Orchid Petal/Small Size)</b>	
1 pc./pack	3 packs/box
Package Size	8.66 x 4.02 x 0.28 in

<b>8487</b>	
<b>Kanzashi Flower Maker (Orchid Petal/Large Size)</b>	
1 pc./pack	3 packs/box
Package Size	8.66 x 4.41 x 0.28 in

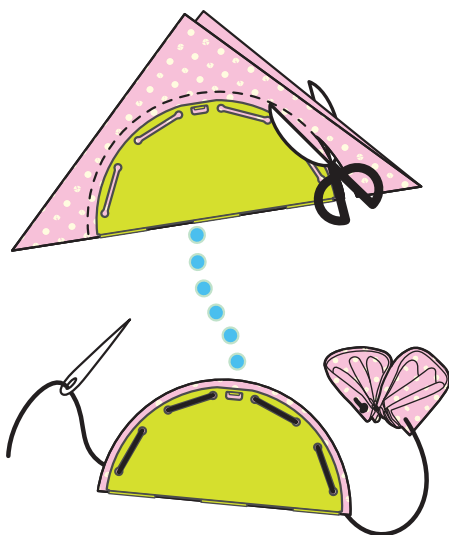

# Needle Felting Tools

**No thread or glue needed!**

The wool roving fibers stay permanently without using glue or sewing it.



Lock the cover when not in use.

**8900**  
**Needle Felting Tool**

1 set/pack	3 packs/box
Package Size	8.56 x 3.63 x 1.25 in

Has five barbed needles that catches the wool roving fibers and pushes them into the bottom of the fabric. Comes with a clear lock cover for safety and storage.



**8901**  
**Pen Style Needle Felting Tool**

1 set/pack	3 packs/box
Package Size	5.56 x 3.56 x 0.88 in

For small and delicate felt projects using 1, 2 or 3 needles.



- 3 needles For a quick finish
- 2 needles For creating lines and outlines
- 1 needle For delicate work

**Replacement needle for Needle Felting Tool and Pen Style Needle Felting Tool.**

**8905**

**Fine Weight Needle**  
Size 40/Triangle  
(No coating)

**8906**

**Heavy Weight Needle**  
Size 36/Triangle  
(Red Coating)



**8905**  
**Needle Felting Tool Refill Needle (Fine Weight Needle)**

**8906**  
**Needle Felting Tool Refill Needle (Heavy Weight Needle)**

5 pcs./pack	3 packs/box
Package Size	8.75 x 2.56 x 0.25 in

The brush-like mat enables smooth punching with little resistance, and allows the fibers of the appliqué to become well meshed with the basic fabric.



8910  
2 3/4 x 3 1/2 in.

**8910**  
**Needle Felting Mat (Small)**

1 pc./pack	3 packs/box
Package Size	9 x 5.5 x 2 in

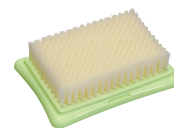

8911  
3-1/4 x 5 in.

**8911**  
**Needle Felting Mat (Large)**

1 pc./pack	3 packs/box
Package Size	9.88 x 5.69 x 1.88 in



**8919**  
**Claw and Mat Cleaner**

1 pc./pack	3 packs/box
Package Size	8.56 x 3.56 x 1 in

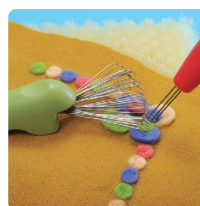

Holds small motifs in the desired position.



Blends wool roving colours together.



Cleans out fibers to the roots of the Needle Felting Mat.

# Natural Wool Rovings

For Needle Felting, Pom-Pom Makers, and other yarn crafts.



100% Wool  
Net: approx. 20g



<b>7920-7939</b>	
<b>Natural Wool Roving</b>	
1 pc./pack	3 packs/box
Package Size	7.25 x 3.88 x 2 in

	<b>7920</b>	
Off White		

	<b>7921</b>	
Lime Green		

	<b>7922</b>	
Moss Green		

	<b>7923</b>	
Blue		

	<b>7926</b>	
Pink		

	<b>7927</b>	
Red		

	<b>7929</b>	
Gold		

	<b>7931</b>	
Brown		

	<b>7932</b>	
Black		

	<b>7933</b>	
Ash		

	<b>7935</b>	
Caramel		

	<b>7939</b>	
Light Blue		

# Swift Bead

Quick beading needles.



<b>2300</b>	
<b>Swift Bead</b>	
	
2 pc./pack	3 packs/box
Package Size	5.91 x 1.97 x 0.08 in

Quickly string your beads with the Swift Bead.

Great to use for crochet and knitting with beads.

Add beaded fringe to your projects, and embellish with beads.

- Needle length: 3 in. (75 mm)
  - Suitable beads: 15/0 - 11/0
- \*Round beads, cylinder beads, etc.

### How to use

\*Loose beads should be put in a long, narrow container.

1. Put a string through the needle.
2. Move the needle up and down.
3. Pull string through the beads.

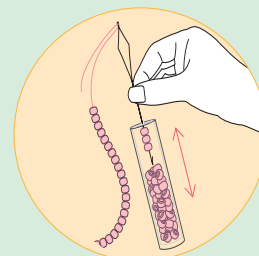

# French Knitter

Create dazzling accessories with beads on nylon, yarns, and embroidery threads.



**3100**  
**French Knitter**  
**—Bead Jewelry Maker—**

1 set/pack	3 packs/box
Package Size	8.66 x 4.92 x 1.5 in

- Contents**
- Main body: 1 pc.
  - Crochet Hook: 1 pc.
  - 4-peg Head: 1 pc.
  - 5-peg Head: 1 pc.
  - 6-peg Head: 1 pc.



3 interchangeable heads included

# Wonder Knitter

*The sweet old spool knitting has come back in a cute design!*

The Wonder Knitter is extremely easy to use and you'll never get tired of knitting!



**3101**  
**Wonder Knitter™**

1 set/pack	3 packs/box
Package Size	8.63 x 4.75 x 2.25 in

The rotating disk makes knitting easy and fast. A variety of materials can be used, such as beads and nylon string.

- Contents**
- Main body: 1 pc.
  - Crochet Hook: 1 pc.
  - 3-peg Head: 1 pc.
  - 6-peg Head: 1 pc.



**The secret of easy knitting is the rotating disc**

Turn the disc and the thread will automatically come into place. No need to adjust thread position and tension for easy knitting.



Pick up lower stitch. Hook over upper yarn onto pin. Rotate disk and continue.

**Change the disc with just one touch!**

Use 3 pins to knit a thin cord and 6 pins to knit a thick cord.  
 Knit cords of two different sizes by changing the disc.  
 Easy and quick knitting!



# Bracelet Maker

Make decorative bracelets by knotting and weaving threads.

Create 8 different bracelet styles with a variety of decorative yarns, threads and beads.



**9943**  
**Bracelet Maker**

1 set/pack	3 packs/box
Package Size	10.24 x 2.52 x 1.34 in

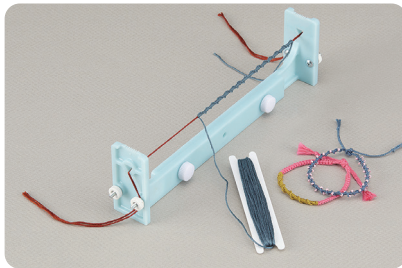

You can make your favorite bracelet combining the techniques you choose for each of Part-A and B.



Enjoy 8 creative style variations.

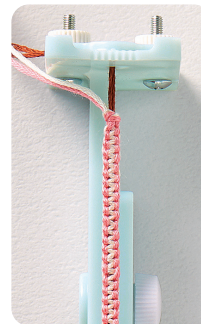
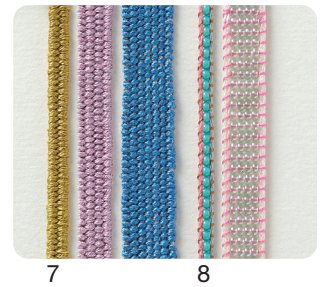
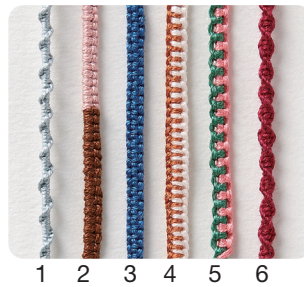

Knotting

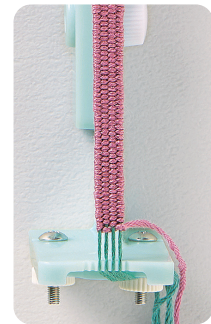

Weaving

# Flower Loom

Setting a frame on the loom base and mending a thread with the pin are all you need to do make a flower motif!

Enjoy making a variety of motifs through many different frames, combinations and ways of binding and mending!



**3146**  
**Flower Loom**

1 set/pack	3 packs/box
Package Size	8.63 x 5 x 2 in

Create beautiful fun-flowers in every season with wool, yarn, ribbon or raffia in different shapes and sizes. The Flower Loom is the perfect embellishing tool for all ages. The flowers can be joined together to make beautiful wearable art, home decor accessories such as pillows, trimmings, and bags.



Connect motifs to make a bag!



Accentuate your needlework with a corsage!

## How to use

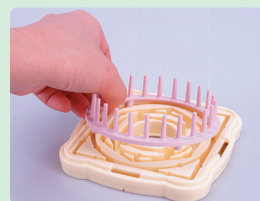

1. Set the loom on the base.



2. Wind the yarn around the pegs in a criss-cross fashion.



3. Weave the yarn around each petal to make the center.



4. Finish!

# Beading Loom

Enjoy making a variety of beaded art of many different sizes!

*Beading made simple.*

Perfectly assembled and gentle on even the most intricate projects.

The sophisticated thread holder keeps the warp threads precisely in place and makes beading easy for beginners as well.



**9910**  
**Clover Beading Loom**

1 set/box  
 Package Size 11.81 x 4.72 x 3.15 in

Create everything from accessories to embellishments.

\* Package does not include beads or thread.



Shortest position

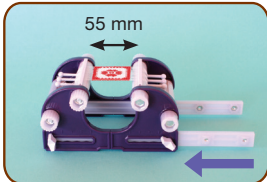

Longest position

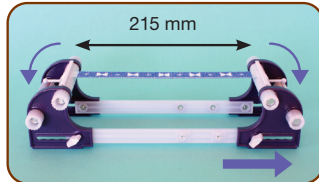

\*Wind woven piece onto winding beam to create even longer works.

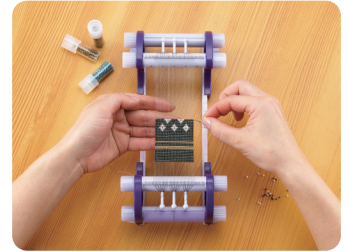

Stopper for preventing the warp threads coming undone.

Round beads (11/0) and small round beads can be used with this loom.

You can create different warp threads to match two different bead sizes.

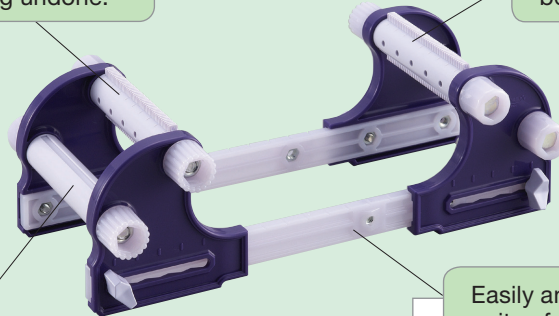

Thread holder for fixing the warp threads in place

With a comb to align and straighten warp threads!

Easily and accurately adjust the thread length in units of 1 cm depending on the size of each work.

- Create beautiful beaded artwork by weaving the ends of threads in with the beads for clean ends.
- You can bead up to 1.3 m by winding the woven works onto the winding beam.
- Easily wind the bead work horizontally with the outer dial.



# Beading Loom Kits

Create beautiful beaded jewelry and accessories with TOHO beads.



**9918**  
**Beading Loom Kit (Tulip Brooch)**

0 51221 79918 1

1 kit/pack	3 packs/box
Package Size	8.86 x 4.92 x 0.43 in



**9921**  
**Beading Loom Kit (Emblem Brooch)**

0 51221 79921 1

1 kit/pack	3 packs/box
Package Size	8.86 x 4.92 x 0.39 in



**9919**  
**Beading Loom Kit (Butterfly Brooch)**

0 51221 79919 8

1 kit/pack	3 packs/box
Package Size	8.86 x 4.92 x 0.35 in



**9922**  
**Beading Loom Kit (Pendant Necklace)**

0 51221 79922 8

1 kit/pack	3 packs/box
Package Size	8.86 x 4.92 x 0.39 in



**9920**  
**Beading Loom Kit (Rose Brooch)**

0 51221 79920 4

1 kit/pack	3 packs/box
Package Size	8.86 x 4.92 x 0.35 in



**9923**  
**Beading Loom Kit (Bracelet)**

0 51221 79923 5

1 kit/pack	3 packs/box
Package Size	8.86 x 4.92 x 0.31 in



**9913-9916**  
**Beading Thread #60 Wt. 218 yds**

1 pc./pack	3 packs/box
Package Size	5.91 x 2.56 x 1.22 in

100% polyester beading thread.

	<b>9913</b> Beige	0 51221 79913 6		<b>9915</b> Green	0 51221 79915 0
	<b>9914</b> Brown	0 51221 79914 3		<b>9916</b> Light Grey	0 51221 79916 7

# Mini Weaving Loom

**Simple and Easy!**

Easily create woven motifs.  
Many varieties of motifs result from different warp settings and yarn selections!



**3177**  
Mini Weaving Loom (Double)

1 set/pack	3 packs/box
Package Size	10.12 x 6.5 x 1.46 in

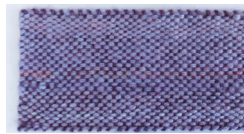
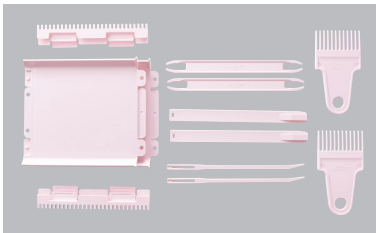

Finished size: Approx. 4 3/4 in sq.

\*Use the Weaving Loom also as a single.

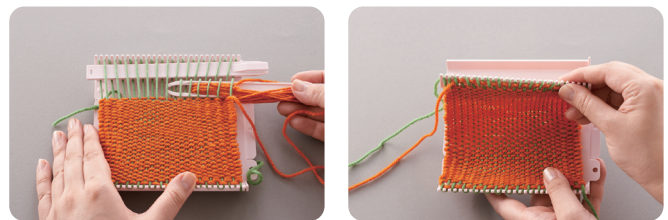
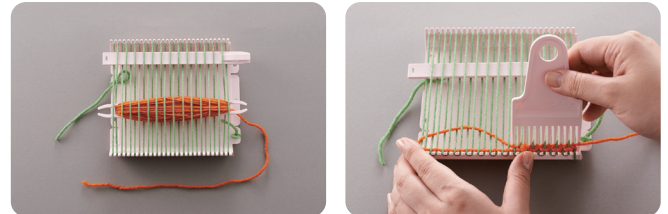
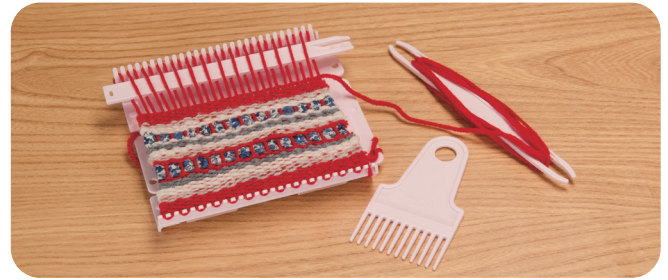

# Picot Comb

**Make successive picots of different heights without the struggle!**



**8115**  
Picot Comb (Large)

1 pc./pack	3 packs/box
Package Size	7.28 x 2.76 x 0.59 in



Large: Thick lace thread (#10-#50)



**8116**  
Picot Comb (Small)

1 pc./pack	3 packs/box
Package Size	7.28 x 2.76 x 0.59 in



Small: Thin lace thread (#60-#100)

Use this tool to make tatting-lace picots of the same size.

- Picots of 10 different heights can be made.

Large: about 1.2-17.9 mm  
Small: about 1.0-11.8 mm

\*Varies according to the number of comb teeth used

- Choose your picot comb according to the thickness of the thread you will use.

Large: thick lace thread (#10-#50)  
Small: thin lace thread (#60-#100)

\*Thickness of thread differs by manufacturer.  
\*These values are given as a guide. Please use the thread you prefer. However, do not use thread that is too thick for the gaps between the comb's teeth.

Height of the picot

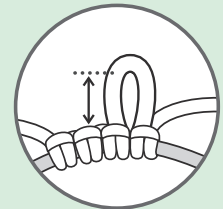

# Tatting Shuttles



**479**  
**Tattling Shuttle**

2 pcs./pack	3 packs/box
Package Size	6 x 3 x 0.63 in

\* Assorted 2 pcs. from these 5 colours.



**8107**  
**Spare Bobbin Set (White)**

**8108**  
**Spare Bobbin Set (Brown)**

1 set/pack	3 packs/box
Package Size	7.28 x 3.15 x 0.59 in

Spare Bobbin sets are for exclusive use with Bobbin Tatting Shuttles.



**8110**  
**Storage Case for Tatting Shuttle**

1 set/pack	3 packs/box
Package Size	8.27 x 4.33 x 1.26 in



This case can store tatting shuttles including L size.



**8109**  
**Storage Case for Bobbin Tatting Shuttle**

1 set/pack	3 packs/box
Package Size	8.27 x 4.33 x 1.26 in



This case can store a set of tatting shuttles and bobbins.

# Hair Pin Lace Tool

Easily braid scarves, chokers, stoles, and so on.

Change blade width with the pin position.



**3104**  
**Hair Pin Lace Tool**

1 set/pack	3 packs/box
Package Size	8.8 x 5.8 x 0.8 in

"Hair Pin Lace" is a traditional interwoven braid that can be made using a basic technique known as "single crochet".

Make braid widths: 2 - 8 cm. You can set every 1 cm.

**As the ends clip on and off:**  
 You can quickly make long braids without any interruption.

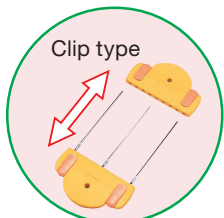

**How to use:**

Make braids with single crochet stitches using a crochet hook.

After a length of braid has been made, put the second clip on upper end.

Remove the lower clip and slip the braid downward.

Replace lower clip, leaving some of the braid on the pins. Remove upper clip and continue braid making.

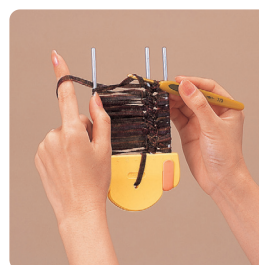

**With 3 pins:**

Set a third pin in the middle for an even more beautiful braid.

As there are holes in the pin, you can pass other threads through the braid while braiding.

This lace tool can even be used for a variety of purposes, including connecting braids and make gathers.

# Weaving Sticks

Fun and easy weaving!



<b>8440</b>	
<b>Weaving Sticks (Thin)</b>	
6 pcs./pack	3 packs/box
Package Size	10.43 x 2.8 x 0.43 in

Create unique accessories and decorations.



# Macrame Plant Hanger Gauge



<b>8630</b>	
<b>Macrame Plant Hanger Gauge</b>	
1 pc./pack	3 packs/box
Package Size	11.61 x 4.53 x 0.75 in

Projects with unique designs can be created combining different types of macramé knots.

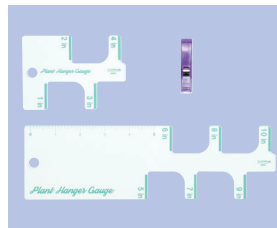

- Using this gauge, knots can be spaced evenly resulting in a beautiful finish
- With 1 in. (approximately 2.5 cm) increments, the gauge can be used to measure from 1 to 10 inches (approximately 2.5 to 25 cm)
- Package includes a Wonder Clip to make holding the gauge in place easier.

# Trace 'n Create Templates with Nancy Zieman



<b>9577</b>	
<b>Trace 'n Create Templates E-Tablet &amp; Paper Tablet Keepers 2.0</b>	
1 set/pack	3 packs/box
Package Size	13.58 x 10.16 x 0.12 in

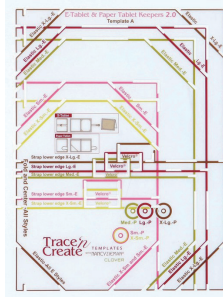

Create personalized tablet keepers for paper or electronic tablets such as Kindle Fire, Kindle 2nd Generation, Samsung Galaxy Tablets and more. Now you write, read or e-mail in style.



# Wrap 'n Fuse Piping



<b>9518</b>	
<b>Wrap 'n Fuse Piping</b>	
1 set/pack	3 packs/box
Package Size	17.13 x 3.25 x 1.88 in

(9 mm x 5.5 m)

**Create Piping in minutes!**

- Unique feature - Cording is covered with fusible web.
- Create Coordinating piping in minutes!
- Use with light-medium weight fabrics.



# Rosette Makers

It is so easy to create beautiful Rosettes!



**8430**  
**Rosette Maker(Small)**

1 set/pack	3 packs/box
Package Size	8.66 x 4.8 x 0.35 in

The parts set included will enable you to create a Rosette.

### Contents

Plate

### Parts set

Center part

Brooch base (felt)

Stickers

Pin back

		Small maker	
Finished size (approx.)			
		1 3/4 in.	2 in.
Ribbon	Width	1/2 in.	3/4 in. /1 in.
	Length	23 in.	23 in.

## Parts set for the Rosette Maker(sold separately).



**8432**  
**Rosette Parts Set(Small)**

1 set/pack	3 packs/box
Package Size	7 x 3.15 x 0.35 in



### Contents

Center part

Brooch base (felt)

Pin back

Stickers



**8433**  
**Rosette Parts Set(Large)**

1 set/pack	3 packs/box
Package Size	7.48 x 3.15 x 0.43 in



### Contents

Center part

Brooch base (felt)

Pin back

Stickers

# Clover Circle ~Where Creativity Never Ends~



## CC-1 Clover Sewing & Quilting Circle

1 set/pack	1 packs/box
Rack Size	5.5 ft x 18 in x 16 in

Clover's Sewing Circle is a collection of essential sewing tools providing for infinite creative potential. It represents an assembly of the very finest sewing notions manufactured by Clover to fit the needs of virtually any sewing technique for home décor, fashion, quilting, or crafting applications. Featured are tools to measure, mark, cut, pin, and sew. Included are needle threaders, bias tape makers, awls, seam rippers, tracing wheels, fusible products and pressing accessories. Every purposeful tool is arranged systematically on a five panel spinner rack. The ultimate product mix assortment for the complete purveyor of fine sewing notions



## CC-2 Clover Knitting & Crochet Circle

1 set/pack	3 packs/box
Rack Size	5.5 ft x 18 in x 16 in

Clover's Knitting Circle is a collection of essential knitting and crochet tools providing for infinite creative potential. It represents an assembly of the very finest knitting and crochet accessories that meet the needs of virtually every creative technique, both current and emerging. Featured prominently is the Takumi line of premium bamboo knitting needles with new precision points, connectors and cables, Takumi Tunisian Crochet Hook sets, Amour premium crochet hooks and all of the most important knitting and crochet accessories. Every purposeful tool and accessory is arranged systematically on a five panel spinner rack. The ultimate product mix assortment for the complete purveyor of fine knitting and crochet offerings.



## 9010 Black Gold Hand Sewing Needles POP Display/Wall Hanging

72 pc./pack	1 Assortment
-------------	--------------

- Includes 3 of each:
- Quilting size 9, 10, 12 and Assorted
  - Quilting between Size 9, 10, 12 and Assorted
  - Appliqué/Sharps Size 9, 10, 12 and Assorted

Total 72 Needles.



## 9011 Protect and Grip & Natural Fit Leather Thimbles POP Display

36 pc./pack	1 Assortment
-------------	--------------

- Includes:
- 6 pcs - Protect and Grip Thimble (S)
  - 12 pcs - Protect and Grip Thimble (M)
  - 6 pcs - Protect and Grip Thimble (L)
  - 3 pcs - Natural Fit Leather Thimble (S)
  - 6 pcs - Natural Fit Leather Thimble (S)
  - 3 pcs - Natural Fit Leather Thimble (S)

Total 36 Thimbles



## 4057 Desk Needle Threader Assorted (Contains 2 of each color)



1 set/pack	3 packs/box
Package Size	5.75 x 4.375 x 2 in.

6 pieces in a display box. Automatic needle threader. This tool is a must for every sewer and quilter. Easy to use and it threads your needles with a simple push of a button. The threader has a built in cutter. The display box assortment comes with 2 Purple, 2 Green and 2 Pink threaders.





Clover has always prided itself in producing high quality sewing notions that are uniquely useful to our customers. We don't do gadgets. Unfortunately the market place is so full of choices that it is sometimes difficult to separate the wheat from the chaff. To that end we're proud to announce the formation of Clover Tool School. On a bi-monthly basis, or as suitable, Clover will publish an edition of Tool School that focuses on just one product.



**Katrina Walker**

Katrina Walker is a sewing industry professional with a broad range of expertise and extensive live and recorded filming experience. She regularly teaches online for quilt guilds, American Sewing Guild chapters, and for virtual shows such as the Sewing and Stitchery Expo, International Quilt Festival, American Sewing Guild, and Stitches.

Sign Up at  
[clovertoolschool.com](https://clovertoolschool.com)

~Stay Social With Us~

 [blog.clover-usa.com](https://blog.clover-usa.com)

@CloverUSA



@CloverNeedlecraft



# Index (Alphabetical)

5-in-1 Sliding Gauge	9506	62	Gold Eye Chenille Needles	234	35	Quick Locking Stitch Markers	3030-3032	26
A Adapter Hot Knife Tip Blade Refil	9107	78	Gold Eye Embroidery Needles	235	35	“QUICK” Yo-Yo Maker	8700-8703,8708	84
Adapter Iron Tip (Large)	9103	78	Gold Eye Milliners Needles (No. 3, 5, 7, 9)	236	36	Quilt Needle Threader	466	48
Adapter Slim Line Tip	9105	78	Gold Eye Quilting Needles Between	496	34	Quilting Needles	468	34
Adjustable Ring Thimble	610	45	Gold Eye Sharps Needles (No. 10)	237/10	36	Quilting Pins	2508	39
Adjustable Ring Thimble with Plate	611	45	Gold Eye Tapestry Needles	238, 238/24	35	Quilting Pins (Fine)	2509	39
Air Erasable Marker (Purple)	5030-5032	66	H Hair Pin Lace Tool	3104	93	R Refill Cartridge for Chaco Liner Pen Style	4720-4724	64
Amour Crochet Hook	1040B-1040J, 1033-1039	19	Hand-Sewing Needles	9605	60	Retractable Seam Ripper	9603	60
Amour Crochet Hook	1220-1226	20	Heart-Shaped Pins	9604	38	Roll & Press	7812	58
Amour Crochet Hook Set	3672	19	“HERA”™ Marker	490/NV	59	Rosette Parts Set	8432/8433	95
Amour Crochet Hook Set	3675	20	“HERA”™ Marker For Appliqué & Sewing	4002	59	Rotary Cutter	7500-7503	72
Antique Yarn Threader	3114	21	Hold It Precision Stiletto	7807	59	S Sashiko Needles	2007	36
Appliqué Pins	231	39	Hot Hemmer	7806/7813	54	Sashiko Needles (Long Type)	2009	36
B Ball Point Awl	876	47	Hot Ruler	7811/7814/7817	54	Seam Guide	9601	60
Bamboo Crochet Hooks “Takumi”®	3500-3505	13	Huck Embroidery Needles	2012	35	Seam Ripper	463	45
Bamboo Interchangeable Circular Knitting Case (Pink)	3652	14	I Interchangeable Cord Connectors	3650	14	Seam Ripper	482/W	45
Bamboo Knitting Needles “Takumi”	3011-3016	8	Interchangeable Cords	3645-3649	14	Seams Right	9507	53
Bamboo Knitting Repair Hooks	3009	21	Interchangeable Stoppers	3651	15	Self Threading Needles (Assorted)	2006	34
Bamboo Marking Pins	3143	23	Interchangeable Tunisian Crochet Hooks “Takumi”®	3690-3698	15	Silk Pins Boxed	2501	39
Beading Loom Kit	9918-9923	91	Interchangeable Tunisian Crochet Hook “Takumi”® Combo Set	3684	15	Silk Threads	701	68
Beading Needles (No. 10, 13)	233	36	Iron-On Transfer Pencil	5004/5005	65	Slash Cutter	499	74
Beading Thread #60 Wt. 218 yds	9913-9916	91	J Jumbo Cable Stitch Holder Set “U”	3008	29	Snag Repair Needles	2512	37
Bias Tape Maker	464	76	Jumbo Darning Needle Set	340	22	Soft Jumbo Stitch Ring Markers	3108	25
Black Gold Hand Sewing Needles POP Display/Wall Hanging	9010	96	Jumbo Locking Stitch Markers	3109	26	Soft Stitch Ring Markers	3107	25
Black Gold Needles	4960-4983	33	Jumbo Point Protectors	3110/3112	27	Soft Touch Crochet Hook	1022/B-1010/4, 1032/7	17
Bodkin (2 Types)	4001	51	Jumbo Stitch Ring Markers	354	25	Soft Touch Crochet Hook	1020-1027	17
Bordeaux Ultimate Scissors 130	4940	70	Jumbo Tapestry Needles Bent Tip	219	22	Soft Touch Thread Pick	4910	51
Bordeaux Ultimate Scissors 170	4941	70	Jumbo Wonder Clips (24 pcs.)	3157	42	Spare Bobbin Set	8107/8108	93
Bracelet Maker	9943	89	K “Kantan Couture” Bead Embroidery Tool	9900	80	Split Ring Markers	347	25
Buttonhole Cutter	484/W	46	“Kantan Couture” Bead Embroidery Tool Needle Refill	9901	80	Spring Tape Measure	9610	60
C Cable Stitch Holders	330	29	Kanzashi Flower Maker	8483-8487	85	Stack ‘n Store Bobbin Tower	9508	63
Cable Stitch Holders (U-Shaped)	341	29	Knitting Accessory Set	3003	28	Stitch Dome	8830	81
Chaco Liner	469	63	Knitting Accessory Set for Beginners	3034	26	Stitch Guide	9584	61
Chaco Liner Pen Style	4710-4714	64	Knitting Accessory Set for Socks	3035	26	Stitch Markers Triangle	3148-3150	25
Chaco Liner Refill	470	63	Knitting Bobbin Set	332	29	Stitch Ring Markers	329	25
Chacopel Fine	418	65	Knitting Counter	336	24	Storage Case for Bobbin Tatting Shuttle	8109	93
Chacopen Blue with Eraser	5012/5013	66	Knitting Needle Gauge	3147	23	Storage Case for Tatting Shuttle	8110	93
Circular Knitting Needles PRO “Takumi”®	3300-3357	5	Knitting Needle Tube Case <Designer Case> Purple	3120	30	Straight Tailor’s Awl	485/W	47
Circular Stitch Holder	3161/3162	28	Knitting Register	328	24	Super Jumbo Tapestry Needle Set	3113	22
Claw and Mat Cleaner	8919	86	L Lace Darning Needle Set	3168	22	Supersize 5-in-1 Sliding Gauge	9585	62
Clip ‘n Glide Bodkin	9582	51	Leather Thimble	612	43	Swatch Ruler and Needle Gauge	3200	23
Clover Beading Loom	9910	90	Locking Stitch Markers	353	26	Sweet ‘n Sharp Macaron	4130/4131	47
Clover Embroidery Hoop	8812/8813	80	Locking Stitch Markers with Clip	3165	27	Swift Bend	2300	87
Clover Knitting & Crochet Circle	CC-2	96	Loop Pressing Bars	4052	51	T “Takumi”® Bamboo Interchangeable Circular Knitting Needles	3633-3644	14
Clover Rotary Blade Refill	7508-7515	73	M Macrame Plant Hanger Gauge	8630	94	“Takumi”® Combo Interchangeable Circular Knitting Needles	3683	14
Clover Sewing & Quilting Circle	CC-1	96	Magnet Pin Caddy	9602	60	Tapered Tailor’s Awl	486/W	47
Clover Yarn Threader	3142	21	Magnet Pin Caddy	4105	50	Tassel Maker	9940/9941	83
Coil Knitting Needle Holders	3122/3123	30	Marbled Glass Head Pins	2511	38	Tatting Shuttle	479	93
Coin Thimble (Medium)	6014	43	Marking Pins for Knitting	325	23	The Ultimate Quilt ‘n Stitch Presser Foot	9586	61
Curve Ruler with Mini Ruler	7006	53	Mesh Transfer Canvas	474	57	Thread Clipper “KUROHA”	415	52
Curved Tailor’s Awl	4880	47	Mini Iron	MCI-900	78	Thread Cutter Pendant	454/455	52
D Darning Needle Set	339	22	Mini Iron II™ “The Adapters”	9100/9101	78	Thread Tweezer	522	52
Darning Needle Set (Bent Tip)	3121	22	Mini Knitting Counter	3118	24	Threader	4000	48
Darning Needles with Latch Hook Eye	3160	22	Mini Weaving Loom (Double)	3177	92	Threader with Cutter “PETIT CUT”	478	48
Design Pro Appliqué Mat	4095	56	Mini Wonder Clips	3188/3189	40	Thumb Tacks with Remover	NP100H	39
Desk Needle Threader	4071-4073	49	N Natural Fit Leather Thimble Limited Edition	6038-6040	43	Trace ‘n Create Templates E-Tablet & Paper Tablet Keepers 2.0	9577	94
Desk Needle Threader Assorted (2 of ea.color)	4057	96	Natural Fit Leather Thimbles	6028-6030	43	Tracing Paper “Clover Hachopy”	434	65
Dome Threaded Needle Case	625	50	Natural Wool Roving	7920-7939	87	Tracing Wheel (Blunt Edges)	481/W	46
Double Ended Tunisian Crochet Hook	1305/G-1308/J	16	Needle Felting Mat	8910/8911	86	Tracing Wheel (Serrated Edges)	480/W	46
Double Needle Threader	462/NV	48	Needle Felting Tool	8900	86	Triangle Tailor’s Chalk	432	65
Double Sided Basting Tape	9505	57	Needle Felting Tool Refill Needle	8905/8906	86	U Universal Knitting Counter	3202	24
Double Sided Thimble	616	43	No-Hassle Triangles Gauge	9579	62	V Water Erasable Marker	515/516	66
Double Tracing Wheel	487/W	46	Open Sided Thimble	6017/6018	45	Water Soluble Pencil	5000-5003	65
Double-Ended Stitch Holders	351/352	28	P Patchwork Pins	232	39	Weaving Sticks (Thin)	8440	94
Double-Ended Stitch Holders (Medium)	3006	28	Patchwork Pins (Fine)	2507	39	White Marking Pen (Fine)	517	66
E Easy Loop Turner	472	51	Patchwork Scissors	493	71	Wonder Clips	3155/3156	41
Embroidery Stitching Tool	8800	79	Pattern Chart Marker Set	3164	29	Wonder Clips (100 pcs.)	3159	42
Embroidery Stitching Tool Needle Refill	8801-8804	79	Pattern Cutting Guide	7007	53	Wonder Clips (Assortment)	3183/3185	41
Embroidery Stitching Tool Needle Threader	8810	79	Pen Style Needle Felting Tool	8901	86	Wonder Clips (Neon Green/10 pcs.)	3180	41
Embroidery Threader	8611	48	Picot Comb	8115/8116	92	Wonder Clips <Variety Pack> (26 pcs.)	3190	42
Eraser Pen	518	66	Pin ‘n Stow	9575	50	Wonder Fuse	4090/4091	56
F Fabric Folding Pen	4053	59	Point 2 Point Turner	7803	59	Wonder Knitter™	3101	88
Fabric Folding Pen Liquid	4054	59	Point Protector for Circular Knitting Needles	3004/3005	27	Wonder Pins (20 pcs.)	3210	37
Fabric Tube Maker	4022	75	Point Protectors	333	27	Wrap ‘n Fuse Piping	9518	94
Finger Presser	495	59	Point Protectors and Stopper	3140	27	Y Yarn Ball Winder	3205	31
Flexible Rubber Thimble Set	9615	60	Point Protectors Petit	3141	27	Yarn Cutter Pendant	3105/3106	24
Flexible Rubber Thimbles	6031/6032	44	Pom-Pom Maker	3124-3128	82	Yarn Guide	348/349	24
Flower Head Pins 0.45 mm	2510	38	Pom-Pom Maker Set	3129	82			
Flower Head Pins 0.55 mm	2505	38	Protect and Grip & Natural Fit Leather Thimbles POP Display	9011	96			
Flower Head Pins Boxed	2506	38	Protect and Grip Thimble	6025-6027	44			
Flower Loom	3146	89	Punch Needle	8816	81			
Fork Blocking Pins	3163	23	Punch Needle Hoop	8817	81			
Fork Pins	240/2401	39	Q QUICK BIAS	700	57			
French Knitter —Bead Jewelry Maker—	3100	88	Quick Bias 100 Yards (91 m)	800/BLK	57			
Fusible Bias Tape Maker	4011-4015	77	“Quick Cut” Thread Cutter	7490	52			
Fusible Web	4031/4032	77	“Quick” Desk Needle Threader	4074	49			
G Gold Eye Appliqué Needles	497	34	Quick Locking Stitch Marker Set	3033	26			

# Index (Numerical)

1002/B-1010/J, 1032/7	Soft Touch Crochet Hook	17	336	Knitting Counter	24	611	Adjustable Ring Thimble with Plate	45
1020-1027	Soft Touch Crochet Hook	17	339	Darning Needle Set	22	612	Leather Thimble	43
1040/B-1049/J, 1053-1059	Amour Crochet Hook	19	340	Jumbo Darning Needle Set	22	616	Double Sided Thimble	43
1220-1226	Amour Crochet Hook	20	341	Cable Stitch Holders (U-Shaped)	29	625	Dome Threaded Needle Case	50
1305/G-1308/J	Double Ended Tunisian Crochet Hook	16	347	Split Ring Markers	25	700	QUICK BIAS	57
2006	Self Threading Needles (Assorted)	34	348/349	Yarn Guide	24	7006	Curve Ruler with Mini Ruler	53
2007	Sashiko Needles	36	3500-3505	Bamboo Crochet Hooks "Takumi®"	13	7007	Pattern Cutting Guide	53
2009	Sashiko Needles (Long Type)	36	351/352	Double-Ended Stitch Holders	28	701	Silk Threads	68
2012	Huck Embroidery Needles	35	353	Locking Stitch Markers	26	7490	"Quick Cut" Thread Cutter	52
219	Jumbo Tapestry Needles Bent Tip	22	354	Jumbo Stitch Ring Markers	25	7500-7503	Rotary Cutter	72
2300	Swift Bead	87	3633-3644	"Takumi®" Bamboo Interchangeable Circular Knitting Needles	14	7508-7515	Clover Rotary Blade Refill	73
231	Appliqué Pins	39	3645-3649	Interchangeable Cords	14	7803	Point 2 Point Turner	59
232	Patchwork Pins	39	3650	Interchangeable Cord Connectors	14	7806/7813	Hot Hemmer	54
233	Beading Needles (No. 10, 13)	36	3651	Interchangeable Stoppers	15	7807	Hold It Precision Stiletto	59
234	Gold Eye Chenille Needles	35	3652	Bamboo Interchangeable Circular Knitting Case (Pink)	14	7811/7814/7817	Hot Ruler	54
235	Gold Eye Embroidery Needles	35	3672	Amour Crochet Hook Set	19	7812	Roll & Press	58
236	Gold Eye Milliners Needles (No. 3, 5, 7, 9)	36	3675	Amour Crochet Hook Set	20	7920-7939	Natural Wool Roving	87
237/10	Gold Eye Sharps Needles (No. 10)	36	3683	"Takumi®/Combo Interchangeable Circular Knitting Needles	14	800/BLK	Quick Bias 100 Yards (91 m)	57
238, 238/24	Gold Eye Tapestry Needles	35	3684	Interchangeable Tunisian Crochet Hook "Takumi®" Combo Set	15	8107/8108	Spare Bobbin Set	93
240/2401	Fork Pins	39	3690-3698	Interchangeable Tunisian Crochet Hooks "Takumi®"	15	8109	Storage Case for Bobbin Tatting Shuttle	93
2501	Silk Pins Boxed	39	4000	Threader	48	8110	Storage Case for Tatting Shuttle	93
2505	Flower Head Pins 0.55 mm	38	4001	Bodkin (2 Types)	51	8115/8116	Picot Comb	92
2506	Flower Head Pins Boxed	38	4002	"HERA"™ Marker For Appliqué & Sewing	59	8432/8433	Rosette Parts Set	95
2507	Patchwork Pins (Fine)	39	4011-4015	Fusible Bias Tape Maker	77	8440	Weaving Sticks (Thin)	94
2508	Quilting Pins	39	4022	Fabric Tube Maker	75	8483-8487	Kanzashi Flower Maker	85
2509	Quilting Pins (Fine)	39	4031/4032	Fusible Web	77	8611	Embroidery Threader	48
2510	Flower Head Pins 0.45 mm	38	4052	Loop Pressing Bars	51	8630	Macrame Plant Hanger Gauge	94
2511	Marbled Glass Head Pins	38	4053	Fabric Folding Pen	59	8700-8703,8708	"QUICK" Yo-Yo Maker	84
2512	Snag Repair Needles	37	4054	Fabric Folding Pen Liquid	59	876	Ball Point Awl	47
3003	Knitting Accessory Set	28	4057	Desk Needle Threader Assorted (2 of ea.color)	96	8800	Embroidery Stitching Tool	79
3004/3005	Point Protector for Circular Knitting Needles	27	4071-4073	Desk Needle Threader	49	8801-8804	Embroidery Stitching Tool Needle Refill	79
3006	Double-Ended Stitch Holders (Medium)	28	4074	"Quick" Desk Needle Threader	49	8810	Embroidery Stitching Tool Needle Threader	79
3008	Jumbo Cable Stitch Holder Set "U"	29	4090/4091	Wonder Fuse	56	8812/8813	Clover Embroidery Hoop	80
3009	Bamboo Knitting Repair Hooks	21	4095	Design Pro Appliqué Mat	56	8816	Punch Needle	81
3011-3016	Bamboo Knitting Needles "Takumi"	8	4105	Magnet Pin Caddy	50	8817	Punch Needle Hoop	81
3030-3032	Quick Locking Stitch Markers	26	4130/4131	Sweet 'n Sharp Macaron	47	8830	Stitch Dome	81
3033	Quick Locking Stitch Marker Set	26	415	Thread Clipper "KUROHA"	52	8900	Needle Felting Tool	86
3034	Knitting Accessory Set for Beginners	26	418	Chacopel Fine	65	8901	Pen Style Needle Felting Tool	86
3035	Knitting Accessory Set for Socks	26	432	Triangle Tailor's Chalk	65	8905/8906	Needle Felting Tool Refill Needle	86
3100	French Knitter —Bead Jewelry Maker—	88	434	Tracing Paper "Clover Chacopy"	65	8910/8911	Needle Felting Mat	86
3101	Wonder Knitter™	88	454/455	Thread Cutter Pendant	52	8919	Claw and Mat Cleaner	86
3104	Hair Pin Lace Tool	93	462/NV	Double Needle Threader	48	9010	Black Gold Hand Sewing Needles POP Display/Wall Hanging	96
3105/3106	Yarn Cutter Pendant	24	463	Seam Ripper	45	9011	Protect and Grip & Natural Fit Leather Thimbles POP Display	96
3107	Soft Stitch Ring Markers	25	464	Bias Tape Maker	76	9100/9101	Mini Iron II™ "The Adapters"	78
3108	Soft Jumbo Stitch Ring Markers	25	466	Quilt Needle Threader	48	9103	Adapter Iron Tip (Large)	78
3109	Jumbo Locking Stitch Markers	26	468	Quilting Needles	34	9105	Adapter Slim Line Tip	78
3110/3112	Jumbo Point Protectors	27	469	Chaco Liner	63	9107	Adapter Hot Knife Tip Blade Refil	78
3113	Super Jumbo Tapestry Needle Set	22	470	Chaco Liner Refill	63	9505	Double Sided Basting Tape	57
3114	Antique Yarn Threader	21	4710-4714	Chaco Liner Pen Style	64	9506	5-in-1 Sliding Gauge	62
3118	Mini Knitting Counter	24	472	Easy Loop Turner	51	9507	Seams Right	53
3120	Knitting Needle Tube Case <Designer Case> Purple	30	4720-4724	Refill Cartridge for Chaco Liner Pen Style	64	9508	Stack 'n Store Bobbin Tower	63
3121	Darning Needle Set (Bent Tip)	22	474	Mesh Transfer Canvas	57	9518	Wrap 'n Fuse Piping	94
3122/3123	Coil Knitting Needle Holders	30	478	Threader with Cutter "PETIT CUT"	48	9575	Pin 'n Stow	50
3124-3128	Pom-Pom Maker	82	479	Tatting Shuttle	93	9577	Trace 'n Create Templates E-Tablet & Paper Tablet Keepers 2.0	94
3129	Pom-Pom Maker Set	82	480/W	Tracing Wheel (Serrated Edges)	46	9579	No-Hassle Triangles Gauge	62
3140	Point Protectors and Stopper	27	481/W	Tracing Wheel (Blunt Edges)	46	9582	Clip 'n Glide Bodkin	51
3141	Point Protectors Petit	27	482/W	Seam Ripper	45	9584	Stitch Guide	61
3142	Clover Yarn Threader	21	484/W	Buttonhole Cutter	46	9585	Supersize 5-in-1 Sliding Gauge	62
3143	Bamboo Marking Pins	23	485/W	Straight Tailor's Awl	47	9586	The Ultimate Quilt 'n Stitch Presser Foot	61
3146	Flower Loom	89	486/W	Tapered Tailor's Awl	47	9601	Seam Guide	60
3147	Knitting Needle Gauge	23	487/W	Double Tracing Wheel	46	9602	Magnet Pin Caddy	60
3148-3150	Stitch Markers Triangle	25	4880	Curved Tailor's Awl	47	9603	Retractable Seam Ripper	60
3155/3156	Wonder Clips	41	490/NV	"HERA"™ Marker	59	9604	Heart-Shaped Pins	38
3157	Jumbo Wonder Clips (24 pcs.)	42	4910	Soft Touch Thread Pick	51	9605	Hand-Sewing Needles	60
3159	Wonder Clips (100 pcs.)	42	493	Patchwork Scissors	71	9610	Spring Tape Measure	60
3160	Darning Needles with Latch Hook Eye	22	4940	Bordeaux Ultimate Scissors 130	70	9615	Flexible Rubber Thimble Set	60
3161/3162	Circular Stitch Holder	28	4941	Bordeaux Ultimate Scissors 170	70	9900	"Kantan Couture" Bead Embroidery Tool	80
3163	Fork Blocking Pins	23	495	Finger Presser	59	9901	"Kantan Couture" Bead Embroidery Tool Needle Refill	80
3164	Pattern Chart Marker Set	29	496	Gold Eye Quilting Needles Between	34	9910	Clover Beading Loom	90
3165	Locking Stitch Markers with Clip	27	4960-4983	Black Gold Needles	33	9913-9916	Beading Thread #60 Wt. 218 yds	91
3168	Lace Darning Needle Set	22	497	Gold Eye Appliqué Needles	34	9918-9923	Beading Loom Kit	91
3177	Mini Weaving Loom (Double)	92	499	Slash Cutter	74	9940/9941	Tassel Maker	83
3180	Wonder Clips (Neon Green/10 pcs.)	41	5000-5003	Water Soluble Pencil	65	9943	Bracket Maker	89
3183/3185	Wonder Clips (Assortment)	41	5004/5005	Iron-On Transfer Pencil	65	CC-1	Clover Sewing & Quilting Circle	96
3188/3189	Mini Wonder Clips	40	5012/5013	Chacopel Blue with Eraser	66	CC-2	Clover Knitting & Crochet Circle	96
3190	Wonder Clips <Variety Pack> (26 pcs.)	42	5030-5032	Air Erasable Marker (Purple)	66	MCI-900	Mini Iron	78
3200	Swatch Ruler and Needle Gauge	23	515/516	Water Erasable Marker	66	NP100H	Thumb Tacks with Remover	39
3202	Universal Knitting Counter	24	517	White Marking Pen (Fine)	66			
3205	Yarn Ball Winder	31	518	Eraser Pen	66			
3210	Wonder Pins (20 pcs.)	37	522	Thread Tweezer	52			
325	Marking Pins for Knitting	23	6014	Coin Thimble (Medium)	43			
328	Knitting Register	24	6017/6018	Open Sided Thimble	45			
329	Stitch Ring Markers	25	6025-6027	Protect and Grip Thimble	44			
330	Cable Stitch Holders	29	6028-6030	Natural Fit Leather Thimbles	43			
3300-3357	Circular Knitting Needles PRO "Takumi®"	5	6031/6032	Flexible Rubber Thimbles	44			
332	Knitting Bobbin Set	29	6038-6040	Natural Fit Leather Thimble Limited Edition	43			
333	Point Protectors	27	610	Adjustable Ring Thimble	45			

Distributing in North and South America  
[www.clover-usa.com](http://www.clover-usa.com)

**CLOVER NEEDLECRAFT, INC.**  
1441 S. Carlos Ave Ontario, CA 91761

897330  
MAR 2024  
170RT